

**SECULIFE | IA**  
**Luminance Analyzer with 1° Measuring Angle**

15365

2/8.13



<b>Table of Contents</b>	<b>Page</b>
<b>1 Applications</b>	<b>3</b>
<b>2 Display Panel and Keys</b>	
2.1 The Display Panel and its Elements	5
2.2 The Keypad	6
<b>3 Working with the SECULIFE IA</b>	
3.1 Preparation	6
Replacing the Batteries	6
Self-Test	7
Battery Indicator	7
The Protective Filter	7
3.2 Changing Default Settings (DIP)	8
Unit of Measure, cd/m <sup>2</sup> or fL	8
Modes: Standard and Compact	8
Memory Display: Individual or Groups	9
<b>4 Operation</b>	
4.1 Switching the Instrument On	9
4.1.1 Display On-Time	9
4.2 Measurements	10
4.2.1 Overflow / Underflow Display	10
4.3 Reference Quantity Measurement	11
4.3.1 Ratio A/B	12
4.3.2 Percentage Deviation %A	13
4.3.3 Difference A-B	14
4.4 Setting Correction Factors	16

<b>Table of Contents</b>	<b>Page</b>
4.5 Memory Function	19
4.5.1 Saving Measured Values	19
4.5.2 Editing Measured Values	20
4.5.3 Saving Values with Correction Factor	21
4.5.4 Reading Out Measured Values	21
4.5.5 Clearing Memory	21
4.5.6 Saving Measured Values (in groups)	22
<b>5 Additional Applications</b>	<b>23</b>
5.1 Contact Measurement Attachment	23
5.2 Stationary Use	23
<b>6 PC Software – USB Port</b>	<b>23</b>
<b>7 Accessories</b>	
7.1 Included Accessories	24
7.2 Optional Accessories	24
7.3 Calibration Certificate	25
<b>8 Service Notes</b>	<b>25</b>
<b>9 Technical Data</b>	<b>26</b>
<b>Declaration of Conformity</b>	

## 1 Applications

The SECULIFE IA is a high-precision measuring instrument with a measuring angle of 1°. Luminance measurements at distances of 1 meter to infinity can be performed with the instrument. The SECULIFE IA features mirror reflex optics with a 15° field of view, a sharply marked 1° measuring circle at the center and a focusing mechanism.

The close-up lenses available as accessories make it possible to shorten measuring distance to 34 cm. Luminance can be measured directly at displays with the help of the attachment for contact measurements.

The light sensitive sensor is color corrected, that is its spectral sensitivity is matched to the spectral luminous efficiency of the human eye in daylight  $V(\lambda)$ . Classification of luminance meters is specified in DIN 5032, part 7, and in DIN EN 13032, appendix B. The SECULIFE IA fulfills class B requirements in accordance with these standards. The instrument is equipped with a measured value memory module with up to 1000 memory locations which can be read out and processed either directly via the keypad and display, or via the integrated USB port with the help of the included standard software.

Suitable for the measurement of, for example:

- Monitors in consideration of ambient light,  
for example approval and consistency testing in the field of medical technology in accordance with DIN 6868-57 and IEC 61223-2-5 (quality assurance guideline dated 20 Nov. 2003)
- Street, tunnel and airport illumination
- Illumination at sports facilities
- Contrast measurements at workstations (ASR)
- Illumination in museums and public buildings
- Projection screens (inspection for uniform illumination)

 **Warning: Do not perform measurements with the instrument pointed towards sun.**

 **Eye damage may result, and the light sensor could be damaged as well.**

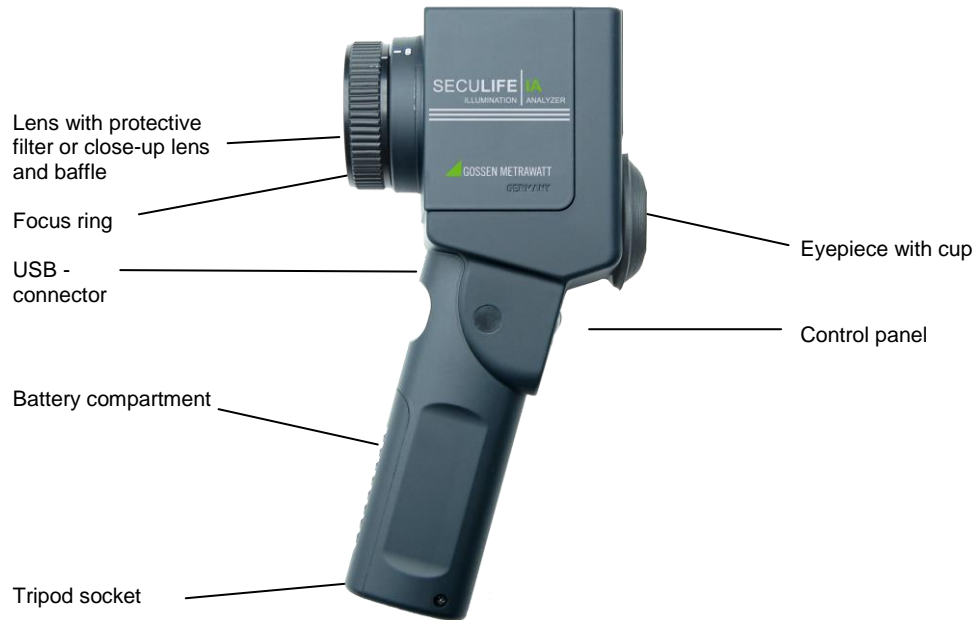
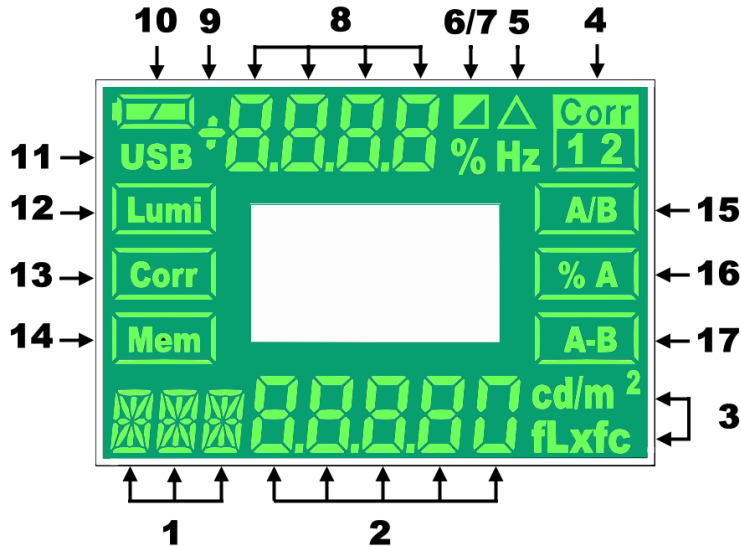

Photo of SECULIFE IA

## 2 The Display Panel

### 2.1 The Display Panel and its Elements



- 1 Memory location display
- 2 Measured value and memory display
- 3 Unit of measure
- 4 Symbol for correction factors 1 and 2
- 5 Difference symbol
- 6 Ratio symbol
- 7 Percentage deviation symbol
- 8 Calculated value, memory group
- 9 Plus or minus sign for calculated value
- 10 Low battery warning display
- 11 USB indicator
- 12 Measuring function
- 13 Correction factor function
- 14 Measured value memory function
- 15 Ratio function
- 16 Percentage deviation function
- 17 Difference function

## 2.2 The Keypad

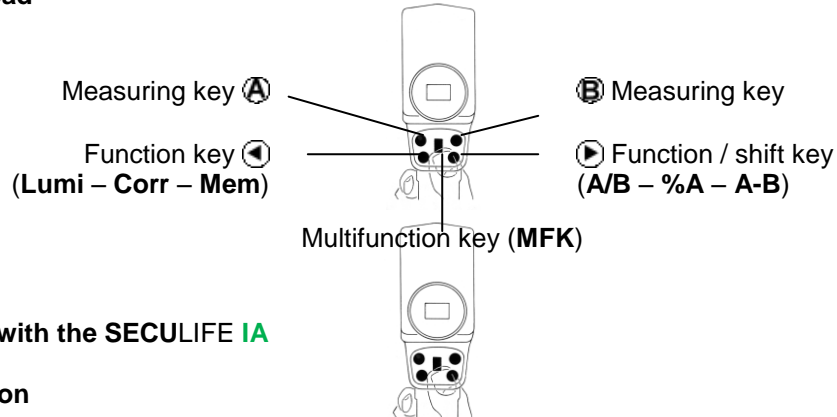

## 3 Working with the SECULIFE IA

### 3.1 Preparation

#### Inserting the Batteries

The battery compartment is located at the front of the grip. Push the battery compartment cover in the grip down. Remove the battery holder with the help of the tab. Replace the batteries assuring correct polarity (+ and -). Insert the battery holder into the instrument and close the battery compartment with its cover.

Approximately 5000 measurements can be performed with a new set of batteries.

**Attention:** Use new batteries only in accordance with IEC LR6 (2 ea. 1.5 V, AA).





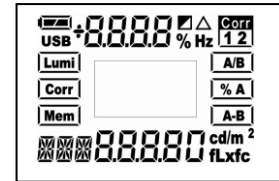

## Self-Test

After inserting the batteries, the microcomputer executes a self-test. All of the elements included in the display panel appear at the display during this test. The display test can be aborted by pressing any key.



## Battery Indicator

The MAVO-SPOT 2 requires two 1.5 V AA batteries (alkaline manganese). The capacity display  indicates the current battery power level. Measured values are retained in memory when the batteries are changed.

-  = The batteries are fully charged.
-  = The batteries are partially discharged – be prepared to replace them.
-  = The batteries are depleted and must be replaced as soon as possible.

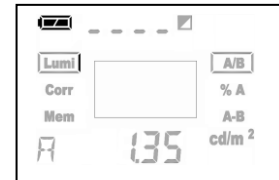

## The Protective Filter

Screw the included protective filter **or** one of the close-up lenses **or** the attachment for contact measurements (optional accessory) onto the lens of your **SECULIFE IA**.

**Either the protective filter, a close-up lens or the attachment for contact measurements (optional accessory) must always be used.**

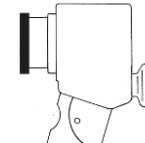

### 3.2 Changing the Default Settings

You can change the default settings for your **SECULIFE IA**. The settings are selected with the help of the DIP switches inside the battery compartment underneath the battery holder. The default settings can be changed as desired in any combination.

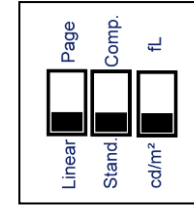

#### Stand. - Comp. DIP switch – selection of standard or compact operating mode

The operating mode can be changed from standard to compact with the **Stand. - Comp. DIP switch**. You can perform measurements and save measured values in the compact mode – the calculation and correction values functions (Corr) are disabled; programmed correction values are nevertheless taken into account (see also section 4.4 on page 16).

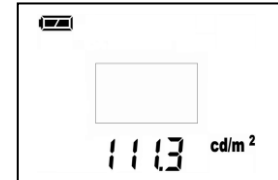
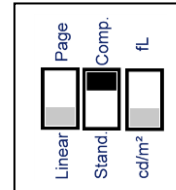
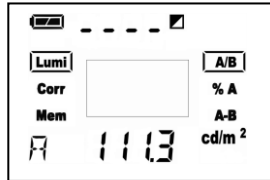
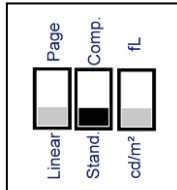

#### cd/m² - fL DIP switch – selection of a of a unit of measure: cd/m² or fL

The desired unit of measure, namely candelas per square meter or foot-lamberts, can be selected with the **cd/m² - fL DIP switch**.

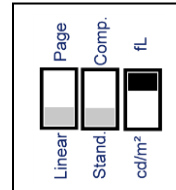
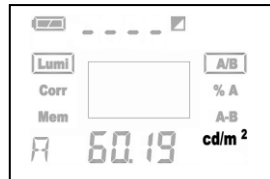
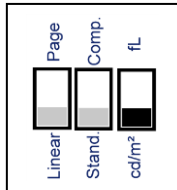



**Linear - Page DIP switch** – selection of 1000 individual memory locations or subdivision into groups (see also section 3.5.2 on page 19)

You can select either consecutive storage of 1000 measured values or subdivision into 10 groups with 100 measured values each with the **Linear - Page DIP switch**. The pages are identified as P-01 through P-10. **Memory content is deleted automatically when the memory location display mode is switched.**

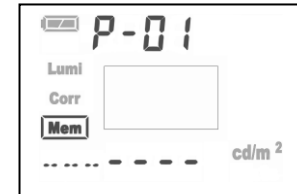
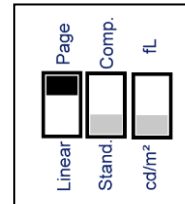
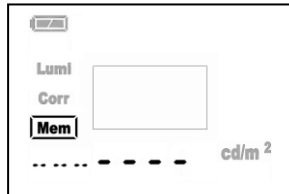
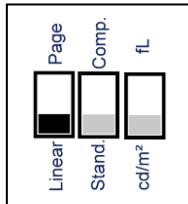

## 4 Operation

### 4.1 Switching the Instrument On

The SECULIFE IA can be switched on by pressing any key.

The measuring instrument is activated and the display panel is illuminated.

The last measured values appear at the display (display memory).



#### 4.1.1 Display On-Time

If none of the keys at the SECULIFE IA are activated for a period of 30 seconds, the instrument is switched off automatically, i.e. the display goes blank but measured values and individual settings are stored to memory.

## 4.2 Measurements

Press the  key to select the **Lumi** function.

Look through the eyepiece on the **SECULIFE IA**, and sharply focus your measuring field with the focusing mechanism at the lens. Now align the measuring circle reflected into the viewfinder to the point to be measured. This point should be uniformly illuminated, and as large as possible relative to the measuring circle.

Press the  key and read the measured value.



### 4.2.1 Overflow / Underflow Display

If the measuring range is exceeded, "----" appears at the display.

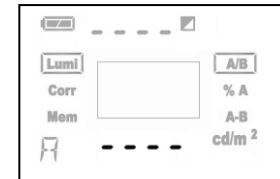
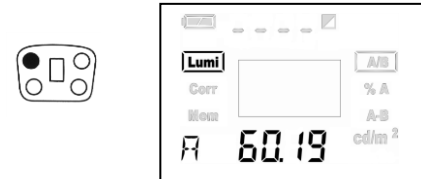
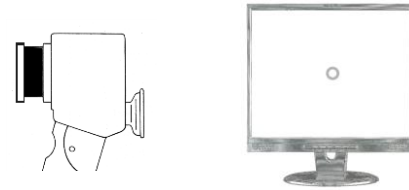

If the measuring range is fallen short of, "0.00" appears at the display.



### 4.3 Reference Quantity Measurement

You can compare two measured values with your SECULIFE IA.

Press the  key in order to select the **Lumi** function to this end.

- Acquire measured value A as described in section 4.2; measured value A is used as a reference value for the following functions.
- Press the  key in order to select the **A/B**, **%A** or **A-B** function.
- Now align the measuring circle to the second point.
- Press the  key; the calculated value for the respective function appears at the upper part of the display.

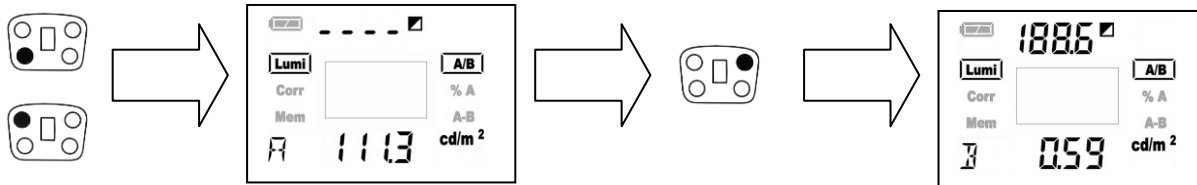

- After acquiring measured value B, calculated value **A/B**, **%A** or **A-B** can be displayed by pressing the  key.

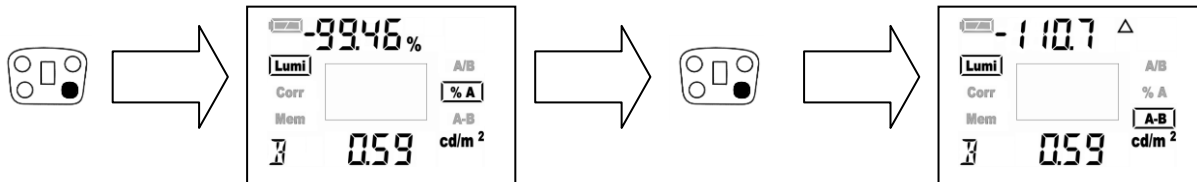

### 4.3.1 Ratio A/B

This function is used, for example, for contrast measurements and luminance distribution at workstations.

- The larger of the two measured values is always used as a dividend; i.e. if measured value B is larger than measured value A, the ratio of the two measured values is calculated as  $B \div A$ .

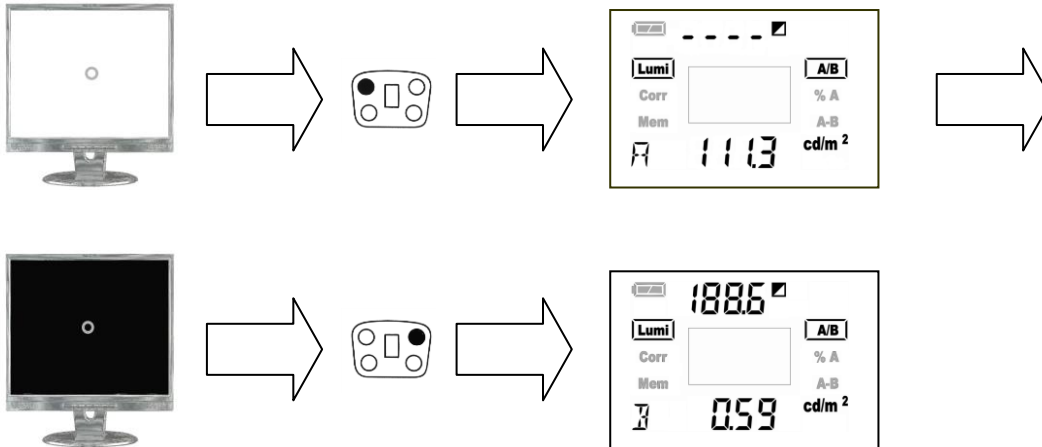

### 4.3.2 Percentage Deviation %A

This function is used, for example, for testing monitor screen uniformity (percentage deviation of screen corners from the reference value at the middle of the screen).

- Depending upon the respective results, the minus sign (-) must be observed.

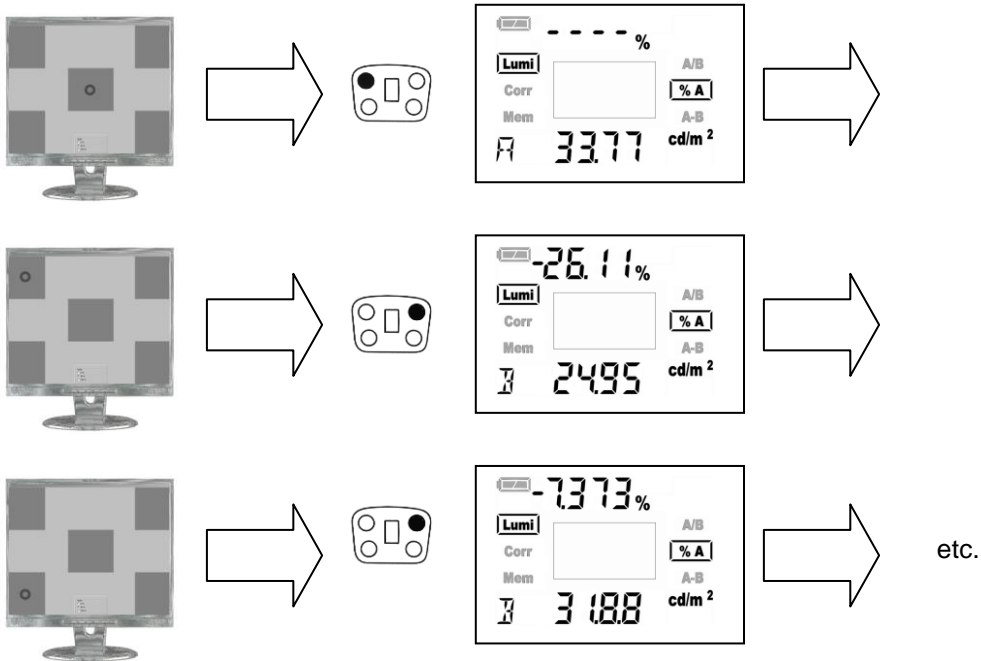

### 4.3.3 Difference A-B

You can read the difference between reference value A and the second measured value (B) directly from the display. This function is used, for example, for detecting deviations in manufacturing.

- Depending upon the respective results, the minus sign (-) must be observed.

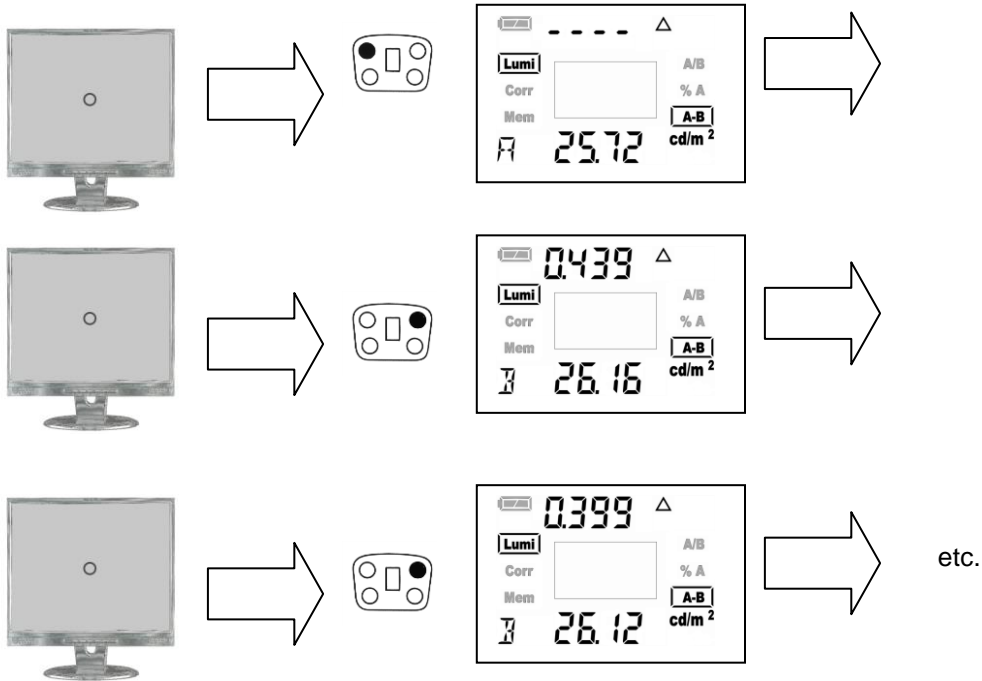

- You can switch back and forth between measured values A and B with the MFK.

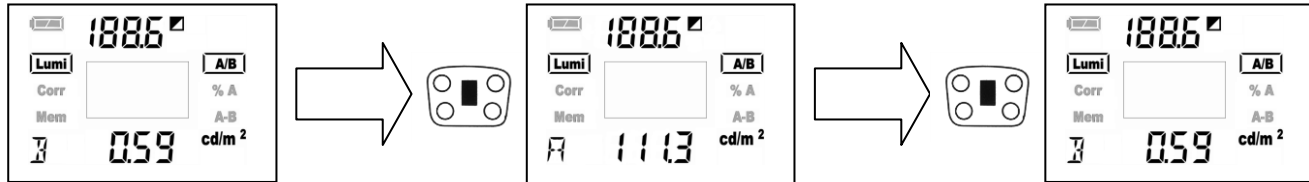

- The reflectivity of ceilings, walls and floors can be measured with the SECULIFE IA in combination with the **reflection standard** (optional accessory). Estimations made with reflection or gloss panels are thus eliminated.
- The reference value is measured against the reflection standard by pressing the **A** key in order to ascertain reflectivity.
- Further measurements executed with the **B** key indicate deviation as a percentage at the upper portion of the display.

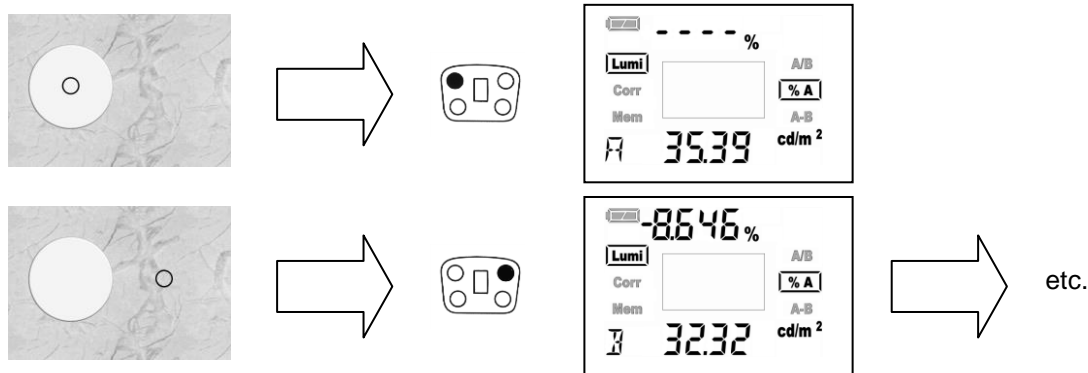

#### 4.4 Setting Correction Factors

As many as two different correction factors can be entered to the SECULIFE IA.

- As default values, Corr1 is set to a factor of 1.000 (no correction) and Corr2 to a factor of 3.142 (illuminance measurement with GOSSEN METRAWATT reflection standard, optional accessory).

Press the  key to select the **Corr** function.

- Select the desired correction factor with the MFK (visible at the top of the display).
- While setting the factor, any measured value shown in the display is correspondingly adjusted (visible at the bottom of the display).

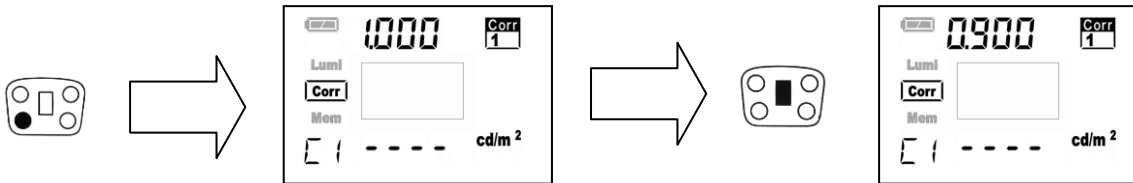

- You can switch back and forth between correction factors 1 and 2 with the  key.

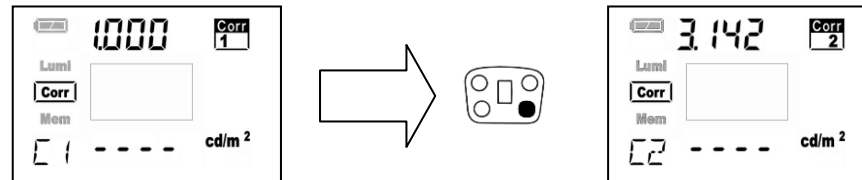



- With the **Corr2** function (factor of 3.142) and the GOSSEN METRAWATT **reflection standard** (optional accessory), you can indirectly measure illuminance (lux or footcandles) with your SECULIFE IA.
- The unit of measure is switched to illuminance (lx or fc) at the display while measurement is being performed.
- The factor 3.142 is the relationship between illuminance (E) and luminance (L) for a perfect reflecting diffuser

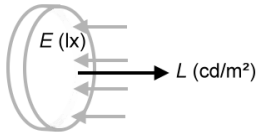

$$E = \pi * L$$

- For a real diffuser (like GOSSEN METRAWATT reflection standard) where reflectance is less than 100%, Corr2 must be adjusted to the actual value. Use the specific value delivered with your standards calibration protocol.

**You can't change Corr factors permanently until you have cleared the entire memory. This precaution is for preventing a mixup of measurements with different Corr factors in memory.**

- The individual factor is saved to correction memory by pressing the **B** key.
- The correction factor is now applied to all measured values shown at the display, which can be saved to memory as well.
- The Corr symbol appears at the upper right hand corner of the display panel in order to indicate a programmed correction factor.

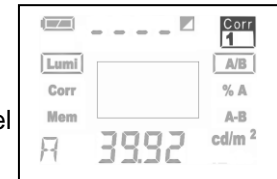

- Save Corr changes permanently

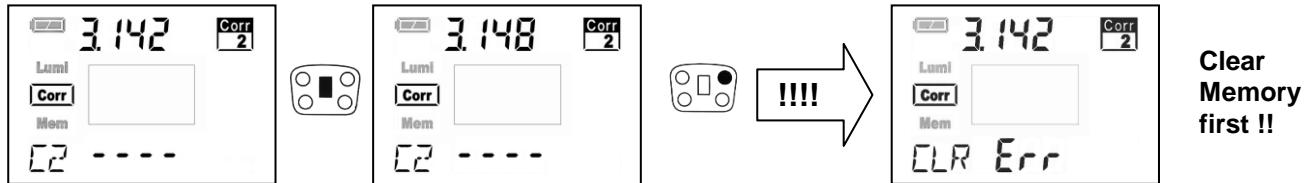

- Take readings with applied corr factors

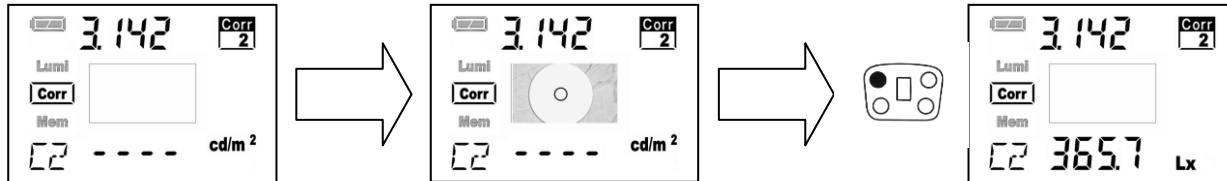

- Reset correction values to factory defaults by simultaneously pressing the **A** and **B** keys.

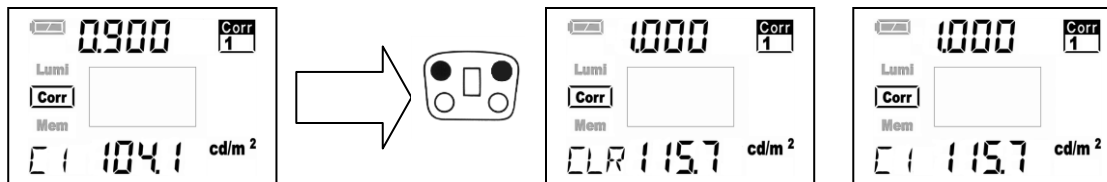

## 4.5 Memory Function

In addition to its display memory, the SECULIFE IA is also equipped with a measured value memory with 1000 memory locations. This function allows you to perform measurements on-site, and to read them out at a later point in time. Stored values are retained when the instrument is switched off, as well as when the batteries are replaced.

### 4.5.1 Saving Measured Values (basic function)

Press the  key to select the **Mem** function.

- Perform measurement as described in section 4.2.
- The displayed value is saved to memory by pressing the  key. STO (stored) appears briefly at the memory location display. In addition to the stored value, the number of the memory location is also displayed. Each additional stored value is saved to the next successive memory location and is assigned the next consecutive location number. FULL appears at the display when measured value memory is full. It is not possible to save a single measured value twice.

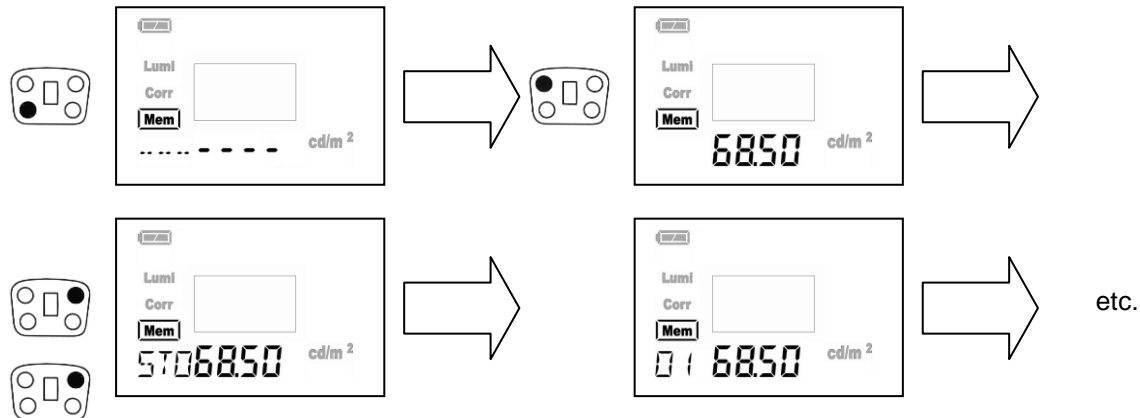



## 4.5.2 Editing Measured Values (Mem-Edit)

Stored measured values can be overwritten with the **Mem** function.

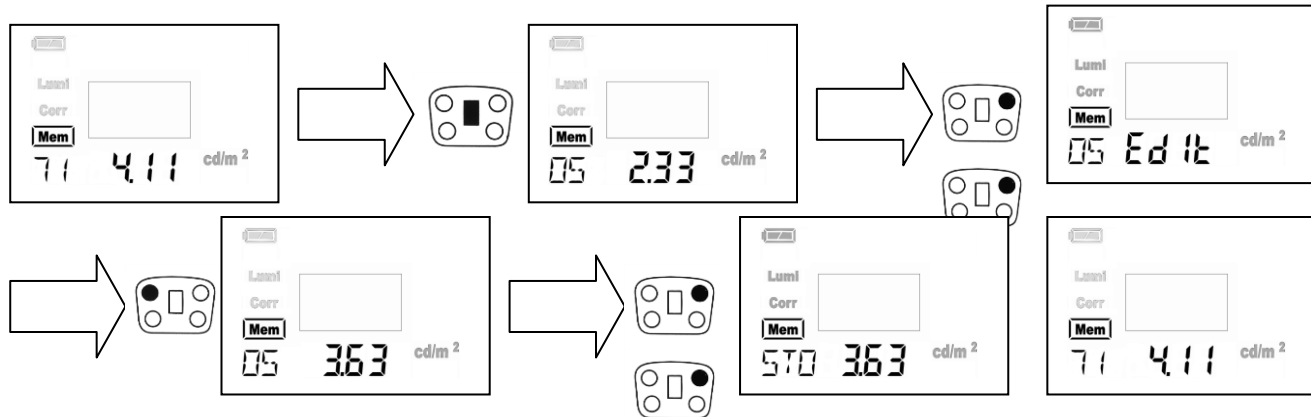
- Select the memory location to be edited with the MFK.
- Press the **⏻** key in order to freeze the memory location.  
“Edit” and the selected memory location is shown in the display indicating that you are up to overwrite the current mem-cell
- Acquire the new measured value as described in section 4.2.
- The displayed value is saved to memory by pressing the **⏻** key.
- The memory location display jumps to the last stored measured value.



### 4.5.3 Saving Measured Values with Correction Factor

If a correction factor has been programmed into the SECULIFE IA (see also page 17), a corresponding display appears automatically. You can now switch back and forth between Corr1 and Corr2 by pressing the  key. Corr2 (a factor of 3.142) is permanently programmed into the instrument – you can switch to illumination measurement with the GOSSEN METRAWATT reflection standard (optional accessory) at any time by pressing the  key.

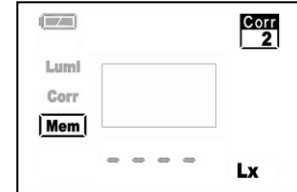

### 4.5.4 Reading Out Measured Values

With the **Mem** function, you can scroll through the measured value memory with the help of the MFK. Each respective stored value is displayed along with the memory location number. The longer the key is pressed and held, the faster the scroll speed becomes.



### 4.5.5 Clearing Memory

Measured value memory can be cleared with the **Mem** function.



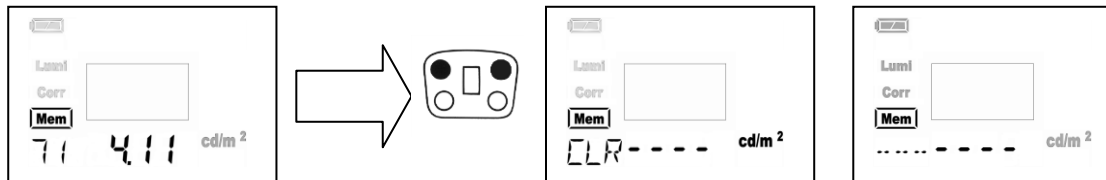

The entire measured value memory is cleared by simultaneously pressing and holding the **A** and **B** keys for at least 2 seconds. CLR appears at the display in order to acknowledge that memory has been cleared. "-----" appears once again at the memory location display.



#### 4.5.6 Saving Measured Values (in groups)

Measured values can also be saved to 10 groups of 100 measuring locations each. This function is accessed by setting the “**Linear - Page**” **DIP switch** in the battery compartment to “Page” (see page 9, Linear - Page DIP switch).

Press the  key to select the **Mem** function. The last used group appears at the display.

- Group selection can be accessed by simultaneously pressing the  and  keys.
- The last used memory group and the designations SEL und PAGE appear at the display.
- Select the group (P-01 through P-10) to which your measurements will be saved with the MFK.
- Group selection can be exited by simultaneously pressing the  and  keys.
- The other memory functions are used as described above.
- Measured values saved to the groups must be individually deleted.

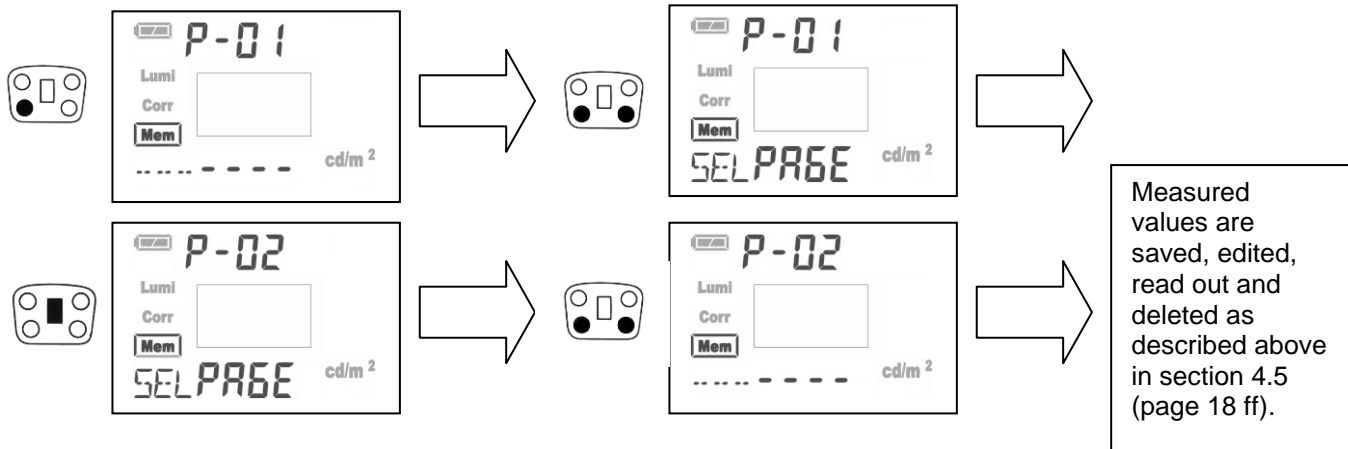

## 5 Additional Applications

### 5.1 Contact Measurement with attachment (optional accessory)

The SECULIFE IA can be placed directly onto a monitor screen or display surface with the attachment for contact measurements. For measurements on flat screens we recommend using the contact measurement adapter as well. Pressure applied to sensitive surfaces is significantly reduced thanks to the large surface area provided by the disc. The danger of damage during measurement is thus considerable reduced.

### 5.2 Stationary Use

Your SECULIFE IA is equipped with a ¼" thread at the bottom for a tripod, and thus fits all commercially available tripod mounts. The protective cap must be attached to the eyepiece as well.

**Light which enters the MAVO-SPOT 2 via the eyepiece influences measurement results!**

## 6 PC Software – USB Port

The SECULIFE IA is equipped with an USB connector. Use the included USB cable to connect the instrument to a computer's USB port. The CD ROM provided with the SECULIFE IA contains standard software (Glux2) by means of which you can get started with PC operation right away. Detailed information regarding PC operation is also provided on the CD ROM.

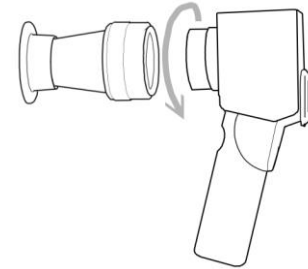

SECULIFE IA with attachment and adapter for contact measurements



## 7 Accessories

### 7.1 Included with the Instrument

- Aluminum case
- Batteries
- Operating Instructions
- Protective Filter
- USB cable
- GLUX2 Software on CD ROM
- Protective lens cap, protective eyepiece cap

### 7.2 Optional Accessories

- Close-up lenses: Test points at distances ranging from 1 meter to infinity can be measured with the SECULIFE IA and the included protective filter. Two different close-up lenses are available for shorter distances.
  - Close-up lens 1 (order no. Z688E): reduces measuring distance to a range of approx. 51 cm to 1 m.
  - Close-up lens 2 (order no. Z688F): reduces measuring distance to a range of approx. 34 cm to 51 cm.**Make sure that either one of the close-up lenses or the protective filter is always attached to the lens. Never attach more than 1 filter to the lens when performing measurements – this causes erroneous measurement results!**
- Attachment for contact measurement (order no. Z688C)
- Reflection standard for illuminance measurement (order no. Z688D)
- Baffle (order no. Z688G)
- Carrying strap (order no. Z688H)



### 7.3 Factory Certificate

Factory certificate upon request (order no. H997B).

The traceability of measurement results to the national standard maintained by the PTB (German Federal Institute of Physics and Metrology) is assured by means of the Wi 41G standard lamp. Depending upon how the instrument is used, we recommend a calibration interval of either 12 or 24 months. Please contact our calibration service for further details (phone: +49-911-8602-172).

### 8 Service Notes

The instrument does not require any special maintenance if used in accordance with the operating instructions.

- Do not touch the front lens!
- If the instrument becomes contaminated during use, clean the surface of the housing with a slightly moistened cloth. If the optics or filter are contaminated, clean them with an optics cleaning cloth. Avoid the use of cleansers, abrasives or solvents.
- Use the instrument under normal ambient conditions. High atmospheric humidity and temperatures of greater than 55° C and less than -20° C should be avoided.
- When not in use, attach the lens cap to the front lens and store the SECULIFE IA in the included aluminum case.
- Do not expose your measuring instrument to excessive temperatures, for example in closed motor vehicles exposed to the sun, or near radiators and the like.
- Never point the front optics towards the sun.
- Do not expose the measuring instrument to strong impacts or vibration.
- Do not attempt to repair or tamper with the instrument. The SECULIFE IA can only be repaired by authorized GOSSEN service personnel.

If your SECULIFE IA should at any time not perform to your satisfaction, or if you'd like to renew your factory certificate, send the instrument to:

GOSSEN Foto- und Lichtmesstechnik GmbH, Lisa-Ammon-Str. 22, 90471 Nürnberg

Phone: +49 (0) 911 8602-181

## 9 Technical Data

<b>Type</b>	Luminance meter with SLR optic and viewfinder display for measuring light-source and surface brightness
<b>Measuring angle</b>	1° <b>Field of view</b> 15° diagonal
<b>Classification</b>	Class B per DIN 5032, part 7, and DIN EN 13032, appendix B, CIE 69
<b>Optical system</b>	77 mm / f/1.8, flare factor $f_2 < 2\%$ ,
<b>Focusing distance</b>	1 meter to infinity, with optional accessories: as little as 34 cm with close-up lens
<b>Light receiver</b>	Silicon photocell with $V(\lambda)$ filter – $f_1 < 3\%$
<b>Luminance units</b>	cd/m <sup>2</sup> or fL (switchable)
<b>Measuring range</b>	0.01 cd/m <sup>2</sup> to 99,990 cd/m <sup>2</sup> , 0.01 fL to 30000 fL, automatic range selection
<b>Measuring modes</b>	Luminance cd/m <sup>2</sup> or fL Luminance ratio A/B, deviation %A, difference A-B 2 independently selectable correction factors CORR Memory function MEM Illuminance (by means of GOSSEN METRAWATT reflection standard as target, optional accessory)

<b>Measured value memory</b>	Up to 1000 individual values or 10 groups with 100 individual values each (switchable)
<b>Display</b>	Viewfinder with back-lit LCD, measured value display with 4-digit precision
<b>Controls</b>	Easy use with 4 keys and 1 slide switch, configuration with DIP switches in the battery compartment
<b>Power supply</b>	Two 1.5 V batteries (IEC LR6, AA type) service life: app. 5000 measurements (with alkaline batteries) battery indicator: multi-segment external power: power is supplied from USB host when operated in PC-mode
<b>Interface</b>	USB 2.0 (compatible with USB 1.1)
<b>Operating temperature</b>	0 °C to 50 °C ( EN 61010-1)
<b>Storage temperature</b>	-20 °C to +70 °C
<b>Miscellaneous</b>	¼" tripod socket
<b>Dimensions</b>	190 x 90 x 57 mm
<b>Weight</b>	Approx. 400 g (without batteries)

**Table 1: SECULIFE IA Characteristics and specifications**

Characteristics (CIE 69, DIN 5032, EN 13032)*	Admissible deviation DIN 5032 class B	SECULIFE IA
V( $\lambda$ ) match - $f_1'$	6 %	$\leq 3,0$ %
Effect from the surrounding field - $f_2(u)$	2 %	$\leq 1,5$ %
Linearity error - $f_3$	2 %	$\leq 1,5$ %
Temperature coefficient - $\alpha_0, \alpha_{25}$	1 %/K	$\leq 0,5$ %/K
Polarization - $f_8$	2 %	$\leq 0,8$ %

- \* CIE 69      Methods of characterizing illuminance meters and luminance meters:  
Performance, characteristics and specifications
- DIN 5032-7      Photometry: classification of illuminance meters and luminance meters
- EN 13032-1      Light and lighting  
Measurement and presentation of photometric data of lamps and luminaries  
**appendix B: characteristics of photometers**



# EG - KONFORMITÄTSERKLÄRUNG - DECLARATION OF CONFORMITY

# GOSSEN

**Dokument-Nr./ Document.No.:** 107/2007  
**Hersteller/ Manufacturer:** GOSSEN Foto- und Lichtmesstechnik GmbH  
**Anschrift / Address:** Lina-Ammon-Str.22  
 90471 Nürnberg

**Produktbezeichnung/ Product name:** **Leuchtdichtemessgerät/Luminance Meter**  
**Typ / Type:** **MAVO-SPOT 2 USB**  
**Bestell-Nr / Order No:** **M508G**

Das bezeichnete Produkt stimmt mit den Vorschriften folgender Europäischer Richtlinien überein, nachgewiesen durch die vollständige Einhaltung folgender Normen:

The above mentioned product has been manufactured according to the regulations of the following European directives proven through complete compliance with the following standards:

<u>Nr. / No.</u>	<u>Richtlinie</u>	<u>Directive</u>
2006/95/EG 2006/95/EC	Elektrische Betriebsmittel zur Verwendung innerhalb bestimmter Spannungsgrenzen - Niederspannungsrichtlinie - - Anbringung der CE-Kennzeichnung : 2008	Electrical equipment for use within certain voltage limits  - Low Voltage Directive - Attachment of CE mark : 2008
<u>EN/Norm/Standard</u> EN 61010-1 : 2001	<u>IEC/Deutsche Norm</u> IEC 61010-1 : 2001	<u>VDE-Klassifikation/Classification</u> VDE 0411-1 : 2002
<u>Nr. / No.</u> 2004/108/EG 2004/108/EC	<u>Richtlinie</u> Elektromagnetische Verträglichkeit - EMV - Richtlinie	<u>Directive</u> Electromagnetic compatibility -EMC directive

Fachgrundform / Generic Standard: EN 61326 : 2006

Nürnberg, den 09.Januar 2008

Ort, Datum / Place, date:

Vorsitzender der Geschäftsführung

**Diese Erklärung bescheinigt die Übereinstimmung mit den genannten Richtlinien, beinhaltet jedoch keine Zusicherung von Eigenschaften. Die Sicherheitshinweise der mitgelieferten Produktdokumentationen sind zu beachten.**

**This declaration certifies compliance with the above mentioned directives but does not include a property assurance. The safety notes given in the product documentations which are part of the supply, must be observed.**

**GMC-I Messtechnik GmbH** is also a leading manufacturer of other interesting light measuring instruments:

- **SECULIFE IT 5032 C USB**: precision digital instrument for illuminance measurement, class C in accordance with DIN 5032, part 7, and CIE no. 69.  
Luxmeter for use in industry and the commercial trades, as well as by government authorities, for preliminary measurements.
- **SECULIFE IT 5032 B USB**: precision digital instrument for illuminance measurement, class B in accordance with DIN 5032, part 7, and CIE no. 69.  
Large measuring range and outstanding sensitivity for approval and certification applications, suitable for, amongst other uses, emergency lighting and industrial measurements.
- **SECULIFE IM**: precision digital instrument for luminance contact measurement, class B in accordance with DIN 5032, part 7, and CIE no. 69.  
Large measuring range and outstanding sensitivity for approval and certification applications, suitable for, amongst other uses, display and viewing devices.
- **SECULIFE IS**: interior light monitoring in accordance with IEC 61223-2-5 (quality assurance guideline dated 20 Nov. 2003). Test intervals for consistency testing at image reproducing apparatus are extended to six months for “veiling luminance” and “maximum contrast” if the instrument is used.

Notes

## Product Support

If required, please contact:

GMC-I Messtechnik GmbH

### Product Support Hotline

Phone +49 911 8602-0

Fax +49 911 8602-709

E-Mail [support@gossenmetrawatt.com](mailto:support@gossenmetrawatt.com)

---

Edited in Germany • Subject to change without notice • A PDF version is available on the Internet



**GOSSEN METRAWATT**

GMC-I Messtechnik GmbH

Südwestpark 15

90449 Nürnberg • Germany

Phone +49 911 8602-111

Fax +49 911 8602-777

E-Mail [info@gossenmetrawatt.com](mailto:info@gossenmetrawatt.com)

[www.gossenmetrawatt.com](http://www.gossenmetrawatt.com)