

METRAport | 40S

Digital Multimeter

3-349-412-02

6/10.14



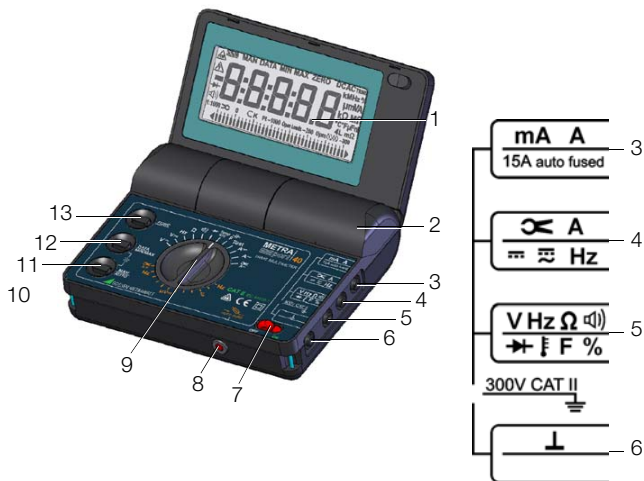

Control Elements

- 1 LCD
- 2 Battery compartment cover
- 3 mA, A connector jack for direct measurement of current to "max. 10 A"
- 4 ∞ A connector jack for current clamp measurement to "max. 30 V"
- 5 Connector jack for all measuring ranges except current measuring ranges
- 6 "⊥" connector jack for all measuring ranges
- 7 **OFF/ON**: ON/OFF switch
- 8 Resettable miniature circuit breaker (AUTO FUSE)
- 9 Rotary switch for function selection
- 10 Eyelet for carrying strap
- 11 **MAN/AUTO**: Key for manual and automatic measuring range selection
- 12 **DATA** and **MIN/MAX**: Key for measured value storage
- 13 **FUNC**: Multifunction key

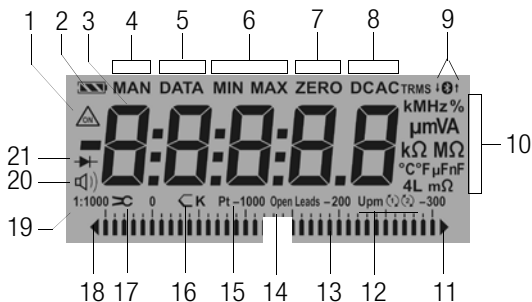

Digital Display Symbols

- 1 Continuous operation
- 2 Battery voltage display
- 3 Digital display with indication of decimal place and polarity
- 4 Manual measuring range selection
- 5 Display memory, "freeze measured value"
- 6 MIN-MAX storage
- 7 ZERO: zero balancing active
- 8 Selected current type, DC (≡) or DCAC (⊖)
- 9 USB Interface display
(when communication is active ↓ ↑ is displayed)
- 10 Unit of measure
- 11 Over-ranging
- 12 RPM measurement: Upm1/Upm2 (at 2/4 stroke engines)
- 13 Pointer for analog display
- 14 Analog display scale
- 15 Resistance thermometer: Pt100 / Pt1000
- 16 Thermocouple: type K
- 17 Current clamp measurement active ∞
- 18 Negative analog display range exceeded
- 19 Transformer ratio (clip factor)
- 20 Acoustic signal activated (e.g. for continuity testing)
- 21 Diode measurement

Contents	Page
1 Safety Features and Precautions	5
2 Initial Start-Up	7
3 Selecting Measuring Functions and Measuring Ranges	8
3.1 Automatic Measuring Range Selection	8
3.2 Manual Measuring Range Selection – MAN/AUTO Key	8
3.3 Quick Measurements	9
4 Display (LCD)	9
4.1 Display Illumination	9
4.2 Digital Display	9
4.3 Analog Display	9
5 Measured Value Storage – DATA / MIN-MAX Key	10
5.1 DATA (hold / compare)	10
5.2 Storage of Minimum and Maximum Values "MIN/MAX" with Time Stamp	11
6 Voltage and Frequency Measurement	12
6.1 Transient Overvoltages	13
6.2 Measuring Voltages of Greater than 300 V	13
6.3 Low-Voltage Measurement	13
7 Current Measurement	13
7.1 Current Measurement with Current (Clamp) Sensors with Voltage Output	15
7.2 RPM Measurement at combustion engines	15
8 Resistance Measurement	16
9 Continuity Testing	16
10 Diode Testing	17
11 Capacitance Measurement	18
12 Frequency Measurement – Duty Cycle Measurement	18
13 Temperature Measurement with Pt100 and Pt1000	19
14 Temperature Measurement with Type K Thermocouple	19
15 Characteristic Values	20
16 Maintenance	26
16.1 Batteries	26
16.2 Fuses	26
16.3 Housing / Opening of Equipment / Repair	27
16.4 Device Return and Environmentally Compatible Disposal	27
17 Multimeter Messages	27
18 Repair and Replacement Parts Service Calibration Center and Rental Instrument Service	28
19 Product Support	28

1 Safety Features and Precautions

You have selected an instrument which provides you with a high level of safety. This instrument fulfills the requirements of the applicable European and national EC guidelines. We confirm this with the CE marking. The relevant declaration of conformity can be obtained from GMC-I Messtechnik GmbH.

The analog/digital multimeter has been manufactured and tested in accordance with safety regulations IEC 61010-1:2010/DIN EN 61010-1:2010/VDE 0411-1:2011. If used for its intended purpose, safety of the operator, as well as that of the instrument, is assured. However, safety cannot be guaranteed if the instrument is used improperly or handled carelessly.

In order to maintain flawless technical safety condition, and to assure safe use, it is imperative that you read the operating instructions thoroughly and carefully before placing your instrument into service, and that you follow all instructions contained therein.

For your safety, as well as for protection of your multimeter, the instrument is equipped with a miniature circuit breaker for the 10 A current measuring range.

Observe the following safety precautions

- The instrument may only be operated by persons who are capable of recognizing contact hazards and implementing appropriate safety precautions. Contact hazards exist anywhere, where voltages of greater than 33 V RMS may occur.
- Avoid working alone when taking measurements which involve contact hazards. Be certain that a second person is present.
- **Maximum allowable voltage between terminals (3), (4), (5), (6) and ground is equal to 300 V, category II.**
- The current measuring range A is equipped with a magnetic circuit breaker. Max. allowable voltage at the meas. circuit (= miniature circuit breaker nominal voltage) is equal to 240 V~ (AC) and 50 V= (DC) against earth in the "mA" and "A" ranges.
- **The instrument may only be used for current measurement in power systems if the electrical circuit is protected with a fuse or a circuit breaker with a rating of up to 20 A, and if nom. voltage at the system does not exceed 240 V~ (AC) or 50 V= (DC). In order to conform to the CAT requirements, an additional slow-blowing fuse link (T16A/500V) has been fitted in series with the miniature circuit breaker which can only be replaced by service personnel once it is tripped.**
- Be prepared for the occurrence of unexpected voltages at devices under test (e.g. defective devices). For ex., capacitors may be dangerously charged.
- Make certain that the measurement cables are in flawless condition, e.g. no damage to insulation, no interruptions in cables or plugs etc.
- No measurements may be made with this instrument in electrical circuits with corona discharge (high-voltage).
- Special care is required when measurements are made in HF electrical circuits. Dangerous pulsating voltages may be present.
- Measurements under moist ambient conditions are not permitted.

- Be absolutely certain that the measuring ranges are not overloaded beyond their allowable capacities. Limit values can be found in the “Measuring Ranges” table in chapter 15, “Characteristic Values”.

Meaning of symbols on the instrument



Warning concerning a point of danger
(Attention: observe documentation!)



Earth



Continuous doubled or reinforced insulation

CAT II

Measurement category II device



Indicates CE conformity



The device may not be disposed of with the trash.
Further information regarding the WEEE mark can be accessed on the Internet at www.gossenmetrawatt.com by entering the search term WEEE.

Calibration mark (blue seal):

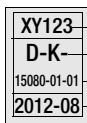

Serial number

German Accrediation Body GmbH – Calibration lab

Registration number

Date of calibraion (year – month)

Repairs, Parts Replacement and Balancing

When the instrument is opened, voltage conducting parts may be exposed. The instrument must be disconnected from the measuring circuit before repair, replacement of parts or balancing. If repair or balancing of a live, open instrument is required, this may only be carried out by trained personnel who are familiar with the dangers involved.

Defects and Extraordinary Strains

If it may be assumed that the instrument can no longer be operated safely, it must be removed from service and secured against unintentional use.

Safe operation can no longer be relied upon:

- If the instrument demonstrates visible damage
- If the instrument no longer functions
- After long periods of storage under unfavorable conditions, e.g. humidity, dust, excessive temperature (see “Ambient Conditions” on page 25).

2 Initial Start-Up

Installing Batteries



Attention!

Disconnect the instrument from the measuring circuit at all poles before opening the battery compartment!

- Fold the instrument closed.
- Insert a coin or a similar object into the slot between the housing and the battery compartment cover and press down until the battery compartment cover snaps open.
- Fold the instrument open as far as it will go and remove the battery compartment cover.
- Insert two 1.5 V mignon batteries per IEC R6 or IEC LR6 into the battery compartment, making sure they are poled in accordance with the symbols.
- Replace the battery compartment cover and press into position until it audibly snaps into place.

Switching the Instrument On

- Set the toggle switch to the "ON" position.

Activation of the instrument is acknowledged with an acoustic signal.

If the instrument has been shut down automatically, press either the FUNC, DATA or MAN key to switch the multimeter back on, or set the toggle switch to the "OFF" position and leave it there for at least 5 s before returning it to the "ON" position.



Note!

Electrical discharges and high frequency interference may lead to erroneous display values, and may disable the measuring sequence. Reset the instrument by switching it off and then, after 5 s, back on again.

Switching the Instrument Off Manually

- Set the toggle switch to the "OFF" position and fold the instrument closed. The battery is automatically disconnected when the multimeter is folded closed.

Automatic Shutdown (standby)

The instrument switches itself off automatically if the measured value remains constant for a long period of time (maximum measured value fluctuation approx. 0.8% of the measuring range per minute, or 1 °Celsius or 1 °Fahrenheit per minute), and if no keys are activated for a period of approximately 10 minutes. Shutdown is acknowledged by a brief acoustic signal. Exception: continuous operation mode.



Note!

Electrical power is supplied to the processor even after the instrument has been switched off automatically. A closed-circuit current of about 200 μA remains. The instrument is only disconnected from the batteries after it has been switched off manually with the toggle switch or with the instrument folded.

Disabling Automatic Shutdown

The instrument can be switched to "CONTINUOUS ON".



- Press the FUNC key while switching the instrument on with the toggle switch until an acoustic signal is generated. The "CONTINUOUS ON" function is indicated at the display with the  symbol.

3 Selecting Measuring Functions and Measuring Ranges

3.1 Automatic Measuring Range Selection

The multimeter is equipped with auto-ranging for all measuring ranges except for temperature measurement, diode and continuity testing. Auto-ranging is always activated as soon as the instrument is switched on. Depending upon the measured quantity, the device automatically selects the measuring range which allows for best possible resolution.

The instrument automatically switches to the next highest or next lowest measuring range for the following measured quantities:

Measuring Ranges	Resolution	Switching to the next highest range occurs at $\pm(\dots d + 1 d)$	Switching to the next lowest range occurs ¹⁾ at $\pm(\dots d - 1 d)$
V \sim , V $\overline{\sim}$, A $\overline{\sim}$, mA \sim , A \sim , Ω , 30 mF, Hz, 	4 $\frac{3}{4}$	31 000	2 800
30 nF ... 300 μ F 	3 $\frac{3}{4}$	3 100	280

3.2 Manual Measuring Range Selection – MAN/AUTO Key

Auto-ranging can be deactivated and ranges can be set manually in accordance with the following table.

The manual mode is deactivated by pressing and holding the MAN/AUTO key for about 1 s, by turning the rotary switch or by switching the instrument off and back on again.

Key MAN/AUTO	Function	Acknowledgement	
		Visual	Acoustic
brief	Manual mode active: utilized measuring range is fixed	MAN	1 x
brief	Switching sequence for: V: 300 mV \rightarrow 3 V \rightarrow 30 V \rightarrow 300 V \rightarrow 600 V \rightarrow 300 mV \rightarrow ... A: 300 μ A \rightarrow 3 mA \rightarrow 30 mA \rightarrow 300 mA \rightarrow 3 A \rightarrow 10 A \rightarrow 300 μ A ... Ω: 30 M Ω \rightarrow 30 Ω \rightarrow 300 Ω \rightarrow 3 k Ω \rightarrow 30 k Ω \rightarrow 300k Ω \rightarrow 3 M Ω \rightarrow 30 M Ω ... F: 30 nF \rightarrow 300 nF \rightarrow 3 μ F \rightarrow 30 μ F \rightarrow 300 μ F \rightarrow 30 nF ... Hz: 300 Hz \rightarrow 3 kHz \rightarrow 30 kHz \rightarrow 300 kHz \rightarrow 1 MHz \rightarrow 300 Hz ...  3.0000 \rightarrow 30.000 \rightarrow 300.00 \rightarrow 3.0000 ...	MAN	1 x
long	Return to automatic measuring range selection	—	2 x

3.3 Quick Measurements

If you wish to perform quicker measurements than those possible with the automatic measuring range selection function, make sure to establish the appropriate measuring range:

- by **manual measuring range selection**, i. e. by selecting the measuring range with the best resolution, see chapter 3.2.
- or
- via **DATA function**, see chapter 5. After the first measurement, the proper measuring range will be automatically determined so that measurements are performed more rapidly from the second measured value onwards.

With both functions, the established measuring range is maintained for the subsequent series mode measurements.

4 Display (LCD)

4.1 Display Illumination

After the instrument has been switched on, background illumination can be activated by briefly pressing the DATA/MIN/MAX and MAN/AUTO keys simultaneously. Illumination is switched back off by once again pressing the same keys, or automatically after approximately 1 minute.

4.2 Digital Display

The measured value appears at the digital display with decimal point and sign (+ or -). The selected unit of measure and the type of current are displayed as well. A minus sign is displayed to the left of the value for the measurement of zero-frequency quantities if the positive pole of the measured quantity is applied to the \perp jack.

If the measuring range upper limit is exceeded for the following measured quantities, "OL" (overload) is displayed:

V $\overline{\text{---}}$ (DC), I $\overline{\text{---}}$ (DC), Ω , Hz, V \sim (AC), I \sim (AC), 30 mF: 30999 digits
30 nF ... 300 μ F: 3099 digits

The digital display is refreshed at different rates for the individual measured quantities (see "Display Refresh Rates" on page 24).

4.3 Analog Display

The analog display with simulated pointer and dynamic response equivalent to that of a moving-coil mechanism, is refreshed 20 times per second. This display is especially advantageous for the observation of measured value fluctuations, and during balancing.

The analog display is equipped with a polarity indicator. The scale is extended 5 segments into the negative range for the measurement of zero-frequency quantities, allowing for precise observation of measured value fluctuation around the zero point. If the measured value exceeds the display range, a triangle is first display at the left, and polarity at the display is reversed approximately 0.7 seconds later. If the measuring range is exceeded (> 30999 digits, in the F range (except 30 mF) : > 3099) a triangle is displayed at the right.







Scaling at the analog display is automatic, which is quite helpful for manual measuring range selection.

5 Measured Value Storage – DATA / MIN-MAX Key

5.1 DATA (hold / compare)

Measured values can be automatically frozen at the display with the DATA (hold) function. This is especially useful when full attention is required for contacting the measuring point. After the measured value has been applied to the multimeter and the “condition” indicated in the following table has been fulfilled, the measured value is frozen at the digital display and an acoustic signal is generated. The test probes can then be removed from the measuring point, and the measured value can be read from the digital display. If the measured value is less than the limit value shown in the table, the instrument is reactivated for a new measurement with the DATA hold function.

If the new measured value deviates from the previous value by less than 100 digits, the acoustic signal sounds twice (DATA compare).

Function DATA	Key DATA	Condition		Reaction at Instrument		
		Measuring Ranges	Measured Value Limits (digits)	Measured Value, Digital	Display DATA	Acoustic Signal
Activate	brief				blinks	1 x
Hold		V, A, Ω , F, Hz, %  ,  , 	> 3.3% of MR OL ³⁾ > 3.3% ³⁾ of range	is displayed	is displayed	1 x 2 x ²⁾
Reactivate ¹⁾		V, A, Ω , F, Hz, %  ,  , 	< 3.3% of MR OL ³⁾ < 3.3% ³⁾ of MR	frozen measured value	blinks	
Deactivate	long			is cleared	is cleared	2 x

¹⁾ Reactivation occurs if the indicated measured value limits are fallen short of.

²⁾ Double acoustic signal after the first measured value has been stored.

Thereafter, double acoustic signal only occurs if the currently frozen value deviates from the **first** stored value by less than 100 digits.

³⁾ Exception: 10% at 300 Ω

Key: MR = measuring range

The DATA function has no effect on the analog display, which continues to indicate the current measured value. However, it must be observed that the decimal place is fixed when the digital display is “frozen”.

The DATA function can be deactivated by pressing and holding the DATA key for about 1 second, by turning the function selector switch or by switching the instrument off and back on again.

5.2 Storage of Minimum and Maximum Values “MIN/MAX” with Time Stamp

Minimum and maximum measured values which occur at the input of the measuring instrument after the MIN/MAX function has been activated can be saved to memory. The most important application for this function is the determination of minimum and maximum values during long-term observation of measured quantities (same function as the slave pointer at an analog display).

The “MIN/MAX” function can be activated for all measuring ranges.

The MIN/MAX function has no effect on the analog display, which continues to indicate the current measured value.

Apply the measured quantity to the instrument and select the measuring range before activating the MIN/MAX function.

Measuring ranges can only be selected manually after the function has been activated, and stored MIN/MAX values and time stamps are deleted in doing so.

The MIN/MAX function is deactivated by pressing and holding the DATA key for about 1 second, by turning the function selector switch or by switching the instrument off and back on again.

Function MIN-MAX	Key DATA	MIN and MAX Measured Values / Time Stamps	Reaction at Instrument		
			Measured Value, Digital	Display MIN MAX	Acoustic Signal
1. Activate and Save	2 x brief	are saved	current measured value	MIN and MAX blink	2 x
2. Save and Display	brief	Storage continues in background, new MIN and MAX values and time stamps are displayed	stored MIN value	MIN	1 x
	brief		time elapsed to stored MIN value	MIN and h:mm:ss	1 x
	brief			MIN and hh:mm	1 x
	brief		stored MAX value	MAX	1 x
	brief		time elapsed to stored MAX value	MAX and h:mm:ss	1 x
	brief			MAX and hh:mm	1 x
3. Return to 1.	brief	same as 1., stored values are not deleted	same as 1.	same as 1.	1 x
Deactivate	long	are deleted	is deleted	is cleared	2 x

6 Voltage and Frequency Measurement

- Set the rotary switch to either $V \sim$ (TRMS) or $V \equiv$, depending upon the voltage to be measured.
- You can switch back and forth between voltage and frequency measurement in the $V \sim$ switch position by pressing the FUNC key.
- Connect the measurement cables as shown. The \perp jack must be grounded.



Note!

An intermittent acoustic signal warns the operator if the measured value exceeds the measuring range upper limit in the 600 V range.



Attention!

Make certain that neither of the current measuring range is selected ("A") and that the measuring cables are connected to the right "V" and "⊥" jacks when the multimeter is connected for voltage measurement! Both the operator and the instrument are in danger if the breaking thresholds for the fuses are exceeded due to operator error!

Zero Balancing in the 300 mV \equiv Measuring Range

- Select the 300 mV \equiv measuring range.
- Connect the measurement cables to the instrument and connect the free ends to one another.
- Briefly press the FUNC key.

The instrument acknowledges zero balancing with an acoustic signal, and "000.00" (± 1 digit) and the ZERO symbol appear at the LCD.

The voltage displayed at the moment the key was pressed is used as a reference value (max. ± 2000 digits which corresponds to 20 mV).

This value is automatically subtracted from all subsequently measured values.

- Zero balancing can be cleared:
 - by pressing and holding the FUNC key, after which clearing is acknowledged by
 - a twice repeated acoustic signal, by switching the instrument off.

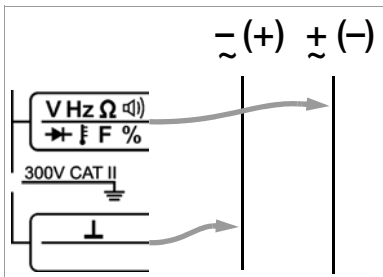

6.1 Transient Overvoltages

The multimeter is protected against transient voltages of up to 4 kV with front and half times of up to 1.2 and 50 μs respectively. Due to the fact that powerful overvoltages must be reckoned with during measurement, for example in power systems, at transformers or motors, we recommend the use of our KS30 measuring adapter in such cases. It offers protection against transient overvoltages of up to 6 kV with front and half times of up to 10 and 1000 μs respectively. Continuous load capacity is equal to 1200 V_{eff} . Additional measuring error due to use of the KS30 measuring adapter amounts to approximately -2% .

6.2 Measuring Voltages of Greater than 300 V

Voltages of greater than 300 V can be measured with a high-voltage measuring probe, for example the HV3¹⁾ of the HV30²⁾ from GMC-I Messtechnik GmbH. The bonding terminal must be grounded in this case. Observe all applicable safety precautions!

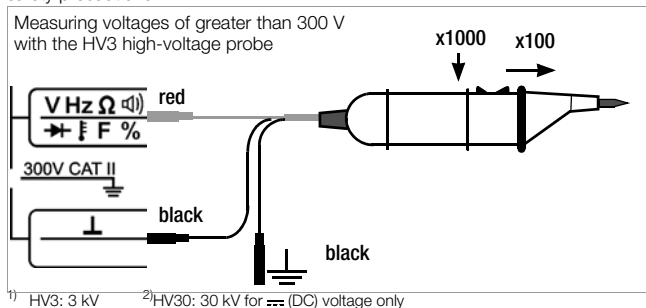

6.3 Low-Voltage Measurement

The instrument is equipped with a special 30 mV measuring range for measuring voltage drop at fuses which is distinguished by high resolution (10 μV) with a low input resistance of 50 k Ω .

- Set the rotary switch to "Temp RTD".
- Select " μV DC" measurement with probe by repeatedly pressing the FUNC key until "mV DC" appears at the display.
- Connect the probe to the " \perp " and "V" sockets.

7 Current Measurement

- First disconnect supply power from the measuring circuit or the power consumer and discharge all capacitors, if any are present.
- Depending upon the type of current, set the rotary switch to "A~" or "A --- ".
- The symbol for the selected current type, --- (DC) or ~ (AC), appears at the LCD.
- Connect the measuring instrument securely to the power consumer in series as shown in the diagram (without transition resistor).

Notes Concerning Current Measurement:

- The instrument may only be used in power installations if the electrical circuit is protected with a fuse or a circuit breaker with a rating of up to 20 A, and if nominal voltage at the system does not exceed 240 V~ (AC) or 50 V \equiv (DC).
- Set up the measuring circuit in a mechanically secure fashion such that it cannot be inadvertently interrupted. Use conductors with an adequate cross section and connectors of adequate size in order to prevent excessive warming.

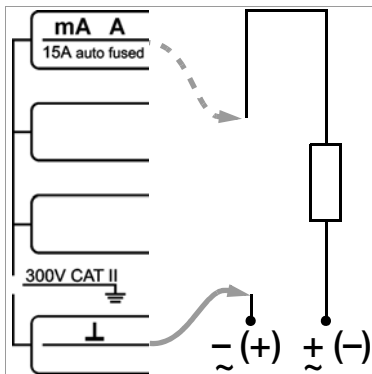

- In the A measuring ranges, an intermittent acoustic signal generates a warning if the measured value exceeds 10 A.
- All measuring ranges up to 10 A are protected by a resettable, 15 A/ 240 V AC/50 V DC auto-fuse. In order to conform to the CAT requirements, an additional slow-blowing fuse link (T16A/500V) has been fitted in series with the miniature circuit breaker which can only be replaced by service personnel once it is tripped.
- If a fuse or circuit breaker in the active current measuring range is tripped, FUSE appears at the digital display, and an acoustic signal is generated simultaneously.
- Eliminate the cause of overload after the fuse or breaker is tripped before placing the instrument back into service!



Attention!

If the secondary side of the current transformer with voltage output remains open during operation, e.g. if cables are defective or have not been connected, or due to a blown device fuse or incorrect connection, dangerous voltages may occur at the terminals.



Note!

Motors with high starting current cause tripping of the circuit breaker, except for measurement with clamp meters.

7.1 Current Measurement with Current (Clamp) Sensors with Voltage Output

If a current sensor is connected to the multimeter, all current values are displayed correctly in consideration of the transformer ratio. This presupposes that the current sensor is equipped with the required sensitivity, and that the appropriate ratio is selected before measurement is performed.

- Turn the rotary switch to the \mathcal{A} position.
- Select a current type, A_{DC} (DC), A_{AC} (AC+DC), Hz, RPM Upm1 or Upm2 (see below), by pressing the FUNC key.
- Simultaneously press the FUNC and the MAN/AUTO keys. The currently selected transformation ratio is displayed. The currently selected transformation ratio is displayed. The transformer ratio can be changed by pressing the MAN or the DATA key, or the currently selected value can be retained by pressing the FUNC key.
- Connect the current (clamp) sensor to the \mathcal{A} and the \perp jacks.

Please observe the specified operating conditions per IEC/EN 61010-2-32 regarding measurement category, etc. for the applied current sensor.

Additional error caused by the current sensor must be taken into consideration.

Current sensor transformer ratio	max. measuring range		Measuring ranges available in the multimeter
	A_{DC}	A_{AC}^*	
1 / 1 V/A	depending on the applied current sensor		0 ... 300.00 mA/3.000 A/30.00 A
1 / 10 V/A			0 ... 3.0000 A/30.000 A/300.00 A
1 / 100 V/A			0 ... 30.000 A/300.00 A/3.0000 kA
1 / 1000 V/A			0 ... 300.00 A/3.0000 kA/30.000 A

* for short-circuited measuring cables: residual value 1 ... 70 d at zero point due to TRMS converter

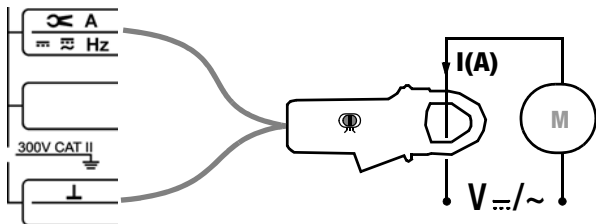

7.2 RPM Measurement at combustion engines

RPM is measured by acquiring pulses. The number of measurable pulses per revolution varies depending upon the type of engine (2 or 4 stroke).

- Set the rotary switch to “ \mathcal{A} ”.
- Press the multifunction key (FUNC) repeatedly until unit of measure Upm1 (RPM measurement at 2 stroke engines: 1 pulse per revolution) or Upm2 (RPM measurement at 4 stroke engines: 1 pulse for 2 revolutions) is briefly displayed. The measured value then appears, for example “244.3 Upm1”.

8 Resistance Measurement

- ⇒ Set the rotary switch to the Ω position. Overload is indicated if no device under test has been connected: “OL M Ω ”.
- ⇒ Before connecting the device under test, make sure that it is voltage-free. Interference voltages distort measurement results! Perform a voltage test first if required.
- ⇒ Connect the device under test as shown in the diagram.

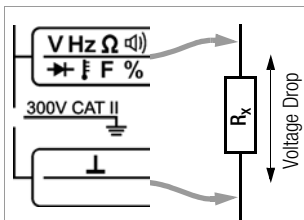

Zero Balancing in the 30 Ω , 300 Ω and 3 k Ω Measuring Ranges

Resistance at cables, as well as contact resistances, can be eliminated for the measurement of low-resistance values in the 30 Ω , 300 Ω and 3 k Ω ranges by means of zero balancing:

- ⇒ Connect the measurement cables to the instrument and connect the free ends to one another (short circuit the test probes).
- ⇒ Briefly press the FUNC key.
The instrument acknowledges zero balancing with an acoustic signal, and “00.00 Ω ”, “000.00 Ω ” or “0.0000 k Ω ” and the ZERO symbol appear at the LCD.
Resistance measured at the moment the key is pressed is used as a reference value (max. 2000 digits). This value is automatically subtracted from all subsequently measured values.
- ⇒ Zero balancing can be cleared:
 - by pressing and holding the FUNC key, after which clearing is acknowledged by a twice repeated acoustic signal,
 - by switching the instrument off.

9 Continuity Testing

With the “acoustic signal” function activated, and exclusively in the 0 to 310 Ω measuring range, the instrument generates a continuous acoustic tone for measured resistance within a range of 0 to approximately 2 Ω .

- ⇒ Turn the selector switch to the Ω position. The Ω and Ω symbols appear at the LCD.
- ⇒ Connect the measurement cables to the device under test.



Note!

Continuity testing is very fast (< 50 ms) and is suitable for locating connections with poor contact (e.g. due to vibration) in automotive service applications.

10 Diode Testing

- Turn the selector switch to the $\rightarrow \blacktriangleleft$ position. Overload is indicated if no device under test has been connected: “OL V”.
- Make sure that the device under test is voltage-free. Interference voltages distort measurement results! Perform a voltage test first if required.
- Connect the device under test as shown in the diagram.

Conducting Direction or Short-Circuiting

Conducting state voltage is displayed in volts at the measuring instrument. As long as voltage drop does not exceed the maximum allowed display value of 5.1 V, several elements or reference diodes with minimal reference voltage can be connected in series for testing. If “OL” appears at the display, either the circuit is interrupted or conducting state voltage is greater than 5.1 V.

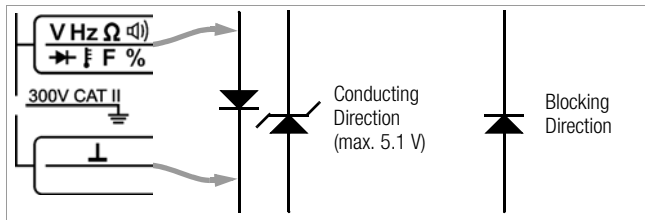

Blocking Direction or Interruption

“OL” is displayed at the instrument. If a value of less than 5.1 V is displayed, this generally indicates that the diode’s blocking direction is defective.



Note!

Resistors and semiconductor paths which have been connected in parallel to the diode distort measurement results!

11 Capacitance Measurement

- ⇒ Make sure that the device under test is voltage-free. Interference voltages distort measurement results!
- ⇒ Turn the rotary switch to the "F" position.
- ⇒ Connect the (discharged!) device under test to the \perp and V jacks with the measurement cables.

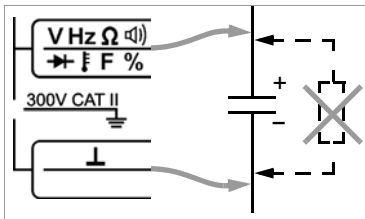

Zero Balancing in the 30 nF Measuring Range

Intrinsic capacitance at the measuring instrument and cables can be eliminated for the measurement of small capacitance values in the 30 nF range by means of zero balancing:

- ⇒ Connect the measurement cables to the measuring instrument without a device under test.
- ⇒ Briefly press the FUNC key. The instrument acknowledges zero balancing with an acoustic signal and "00.00" and the ZERO symbol appear at the LCD. Capacitance measured at the moment the key is pressed is used as a reference value (max. 2000 digits). This value is automatically subtracted from all subsequently measured values.
- ⇒ Zero balancing can be cleared:
 - by pressing and holding the FUNC key, after which clearing is acknowledged by an acoustic signal,
 - by switching the instrument off.

12 Frequency Measurement – Duty Cycle Measurement

- ⇒ Turn the rotary switch to the Hz position.
- ⇒ Apply the measured quantity as described under voltage measurement.
- ⇒ Smallest measurable frequencies and maximum allowable voltages are listed in chapter 15, "Characteristic Values".

The pulse-period ratio can be ascertained for square-wave signals with the duty cycle measurement.

- ⇒ Briefly press the multifunction key twice (FUNC). The instrument is switched to duty cycle measurement. The duty cycle, i.e. the pulse duration of a signal as a percentage, is displayed at the LCD.

$$\text{Duty Cycle (\%)} = \frac{\text{Pulse Duration}}{\text{Period}} \cdot 100$$

Note

The applied frequency must remain constant during duty cycle measurement.

13 Temperature Measurement with Pt100 and Pt1000

- Set the rotary switch to “Temp RTD”.
- Connect the Pt sensor to the \perp and V jacks. The instrument automatically recognizes type of connected sensor (Pt100 or Pt1000), and displays measured temperature in the selected unit of measure.

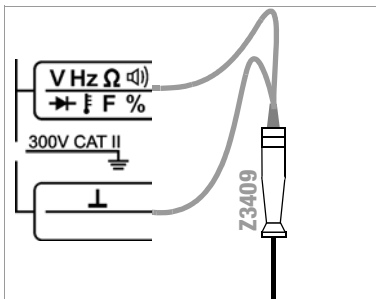

Note!

The characteristic cable resistance for the temperature sensors which are available as accessories is automatically taken into consideration for this measurement.

Temperature Measurement with Compensation for Sensor Cable Resistances from 0.1 Ω to 50 Ω

Sensor cable resistances with values other than 100 m Ω can be compensated for values of up to 50 Ω as follows:

- Briefly press the FUNC and the MAN/AUTO keys simultaneously. The currently selected cable resistance is displayed. This value can be increased with the DATA key, or reduced with the MAN/AUTO key. Each time one of these keys is briefly activated, the value is changed by 10 digits (0.1 Ω). The value can be changed by means of rapid scrolling by pressing and holding the key.
- Switch back to temperature measurement by briefly acknowledging with the FUNC key.

The new cable resistance value is retained, even after the instrument has been switched off.



Note!

The default setting is Pt100/Pt1000 with a cable resistance of 0.1 Ω .

14 Temperature Measurement with Type K Thermocouple

- Set the rotary switch to “Temp RTD”.
- Select “Temp TC K” measurement with thermocouple by repeatedly pressing the FUNC key until °C or °F appears at the display.
- Select temperature unit of measure °C or °F by long pressing the FUNC key.
- Connect the sensor to the “ \perp ” and “V” sockets.

15 Characteristic Values

Measuring Function	Measuring Range	Resolution at MUL		Input Impedance	
		30 000	3 000	—	~
μV DC	30 mV		10 μV	50 kΩ	—
V	300 mV	10 μV		> 11 MΩ	11 MΩ // < 50 pF
	3 V	100 μV		11 MΩ	11 MΩ // < 50 pF
	30 V	1 mV		10 MΩ	10 MΩ // < 50 pF
	300 V	10 mV		10 MΩ	10 MΩ // < 50 pF
	600 V ³⁾	100 mV		10 MΩ	10 MΩ // < 50 pF
Approximate Voltage Drop at MUL					
A	300 μA	10 nA		160 mV	
	3 mA	100 nA		160 mV	
	30 mA	1 μA		180 mV	
	300 mA	10 μA		250 mV	
	3 A	100 μA		360 mV	
	10 A	1 mA		920 mV	
				Open-Circuit Voltage	Meas. Cur. at MUL
Ω	30 Ω		10 mΩ	1.3 V	max. 250 μA
	300 Ω	10 mΩ		1.3 V	max. 250 μA
	3 kΩ	100 mΩ		1.3 V	max. 150 μA
	30 kΩ	1 Ω		1.3 V	max. 30 μA
	300 kΩ	10 Ω		1.3 V	max. 3 μA
	3 MΩ	100 Ω		1.3 V	max. 0.36 μA
	30 MΩ	1 kΩ		1.3 V	max. 0.1 μA
Ω_D)	300 Ω		0.1 Ω	max. 8.4 V	I _K = 1 mA
→	5.1 V ¹⁾	1 mV		max. 8.4 V	I _K = 1 mA
				Discharge Resistance	U_{0,max}
F	30 nF		10 pF	10 MΩ	0.7 V
	300 nF		100 pF	1 MΩ	0.7 V
	3 μF		1 nF	100 kΩ	0.7 V
	30 μF		10 nF	11 kΩ	0.7 V
	300 μF		100 nF	3 kΩ	0.7 V
				f_{min} ²⁾	Power Limit
Hz ⁴⁾	300.00 Hz	0.01 Hz		1 Hz	3 x 10 ⁶ V x Hz
	3.0000 kHz	0.1 Hz		1 Hz	
	30.000 kHz	1 Hz		1 Hz	
	300.00 kHz	10 Hz		1 Hz	
	1.0000 MHz	100 Hz		1 Hz	
%	15...300 Hz: 2.0... 98.0%	0.1 Hz	0.1 Hz	1 Hz	3 x 10 ⁶ V x Hz
	... 3 kHz: 5.0... 95.0%	0.1 Hz	0.1 Hz	1 Hz	
	... 10 kHz: 10.0... 90.0%	0.1 Hz	0.1 Hz	1 Hz	
°C/°F	-200.0 ... +850.0 °C	Pt100	0.1 °C		
	-150.0 ... +850.0 °C	Pt1000			
	-250.0 ... +1372.0 °C	K / NiCr-Ni			

1) Up to max. 5.1 V diode voltage, "OL" (overload) is displayed for higher values.

2) Smallest measurable frequency for sinusoidal measuring signal symmetric to zero point.

3) corresponds to 600 V CAT I

4) Input sensitivity, signal/sine: Hz (V): 10 to 100% MR except for mV: as of 30% MR;
H (I): 20 to 100% MR except for 3 A: as of 30% MR; Hz (clip): as of 30% MR

Key: d = digit(s), rdg. = reading, MR = measuring range, MUL = measuring range upper limit

Measuring Range	Intrinsic Uncertainty under Reference Conditions		Overload Capacity ¹⁾	
	$\pm(\dots \% \text{ rdg.} + \dots \text{ d})$	$\pm(\dots \% \text{ rdg.} + \dots \text{ d})$	Value	Duration
	$\overline{\text{---}}$	$\sim \text{2) 6)}$		
30 mV	1 + 5	—	600 V $\overline{\text{---}}$ (DC) \sim (AC) eff sine	continuous
300 mV	$0.2 + 5^{4)}$	1 + 30		
3 V	0.2 + 3	0.5 + 30		
30 V	0.2 + 3	0.5 + 30		
300 V	0.2 + 3	0.5 + 30		
600 V	0.2 + 3	0.5 + 30		
	$\overline{\text{---}}$	$\sim \text{2) 6)}$		
300 μ A	0.5 + 5	1.5 + 30	0.36 A	dauernd
3 mA	0.5 + 5	1.5 + 30		
30 mA	0.5 + 5	1.5 + 30		
300 mA	0.5 + 5	1.5 + 30		
3 A	0.7 + 5	1.5 + 30		
10 A	0.7 + 5	1.5 + 30		
30 Ω	1 + 5		300 V $\overline{\text{---}}$ (DC) \sim (AC) eff Sinus	max. 10 s
300 Ω	$0.2 + 5^{4)}$			
3 k Ω	$0.2 + 5^{4)}$ [to 1 k Ω : $\pm(0.2 + 9 \text{ D})$]			
30 k Ω	0.2 + 5			
300 k Ω	0.2 + 5			
3 M Ω	0.2 + 5			
30 M Ω	2 + 10			
\square)	3 + 5			
\rightarrow 5.1 V	0.5 + 3		300 V $\overline{\text{---}}$ (DC) \sim (AC) eff sine	max. 10 s
30 nF	$1 + 6^{4)}$			
300 nF	1 + 6			
3 μ F	1 + 6			
30 μ F	1 + 6			
300 μ F	1 + 6			
		Max. Measuring Voltage		
300.00 Hz		300 V	300 V	max. 10 s
3.0000 kHz	0.1 + 5	300 V		
30 kHz	(sinusoidal input voltage > 2 ... 5)	300 V		
300 kHz		100 V		
1000 kHz		30		
%	0.1% MR $\pm 8 \text{ d}$		300 V	max. 10 s
	0.1% MR/kHz $\pm 8 \text{ d}$			
	0.1% MR/kHz $\pm 8 \text{ d}$			
Pt 100	-200.0 ... +850.0 °C	$0.5\% + 15^{5)}$	300 V $\overline{\text{---}}$ (DC) / \sim (AC) eff sine	max. 10 s
Pt1000	-150.0 ... +850.0 °C	$0.5\% + 15^{5)}$		
K / NiCr-Ni	-250.0 ... +1372.0 °C	$1\% + 5 \text{ K}^{5)}$		

1) At 0 ° to + 40 °C

2) Values of less than 2 mV are suppressed in the 300 mV range
15 (20) ... 45 ... 65 Hz ... 10 kHz sine, see page 22 for influences.

3) After measurement with 10 A: at least 10 minute cool-down period

4) If "zero balancing" function is active, ZERO appears at display.

5) Plus sensor error

6) Specified intrinsic uncertainty valid for 3 to 100% of the AC measuring ranges
with short-circuited test probes: residual value 1 to 30 d at zero point due to TRMS converter

7) Intrinsic error values valid as of 10 digits

Influence Quantities and Influence Error

Influence Quantity	Sphere of Influence	Measured Quantity / Measuring Range ¹⁾	Influence Error (... % + ... d) / 10 K
Temperature	0 °C ... +21 °C and +25 °C ... +40 °C	V $\overline{\text{---}}$	0.2 + 10
		V \sim	0.4 + 10
		300 μ A ... 300 mA $\overline{\text{---}}$ + \sim	0.5 + 10
		3 A / 10 A $\overline{\text{---}}$ + \sim	1 + 10
		300 Ω ... 300 k Ω	0.2 + 10
		3 M Ω	0.2 + 10
		30 M Ω	1 + 10
		30 nF ... 30 μ F	0.5 + 10
		Hz / %	0.5 + 10
°C (Pt100)	0.5 + 10		

Influence Quantity	Sphere of Influence (max. resolution)	Frequency	Intrinsic Uncertainty ²⁾ \pm (... % rdg. + ... d)
Frequency $V_{\sim(AC)}$	3.0000 V 30.000 V	> 15 Hz ... 45 Hz	3 + 30
		> 65 Hz ... 1 kHz	1.5 + 30
		> 1 kHz ... 5 kHz	2.5 + 30
		> 5 kHz ... 10 kHz	3 + 30
	300.00 mV 300.00 V 600.0 V	> 15 Hz ... 45 Hz	3 + 30
		> 65 Hz ... 10 kHz	3 + 30

Influence Quantity	Sphere of Influence (max. resolution)	Frequency	Intrinsic Uncertainty ²⁾ \pm (... % rdg. + ... d)
Frequency $I_{\sim(AC)}$	300.00 μ A 3.0000 mA, 30.000 mA 10.000 A	> 15 Hz ... 45 Hz	3 + 30
		> 65 Hz ... 1 kHz	
	300.00 mA	> 15 Hz ... 45 Hz	3 + 30
		> 65 Hz ... 500 Hz	1.5 + 30
		> 500 Hz ... 1 kHz	3 + 30
	3.0000 A	> 15 Hz ... 45 Hz	3 + 30
> 65 Hz ... 500 Hz		1.5 + 30	
> 500 Hz ... 1 kHz		3 + 30	

¹⁾ With zero balancing

²⁾ Indicated error applies as of a display value of 10% of the measuring range.

Influence Quantity	Sphere of Influence	Measured Quantity / Measuring Range	Influence Error ¹⁾
Measured Quantity Waveshape ³⁾	Crest factor CF	1 ... 2	± 1% rdg.
		> 2 ... 4	± 5% rdg.
		> 4 ... 5	± 7% rdg.

Influence Quantity	Sphere of Influence	Measured Quantity / Measuring Range	Influence Error
Relative Humidity	75% 3 days device off	V, A, Ω F, Hz, % °C	1 x intrinsic uncertainty

Influence Quantity	Sphere of Influence	Measuring Range	Damping
Common-Mode Interference Voltage	interference quantity max. 300 V ~ \equiv	V \equiv	> 90 dB
	interference quantity max. 300 V ~ 50 Hz, 60 Hz sine	300 mV ... 30 V ~	> 60 dB
		300 V ~	> 60 dB
Series-Mode Interference Voltage	interference quantity V ~ nom. value, respective measuring range, max. 300 V ~, 50 Hz, 60 Hz sine	V \equiv	> 40 dB
	interference quantity max. 300 V \equiv nom. value, respective measuring range	V ~	> 50 dB

¹⁾ Except for sinusoidal waveshape

Reference Conditions

Ambient Temperature	+23 °C ± 3 K
Relative Humidity	40 ... 75 %
Measured Qty. Frequency	45 ... 65 Hz
Measured Qty. Waveshape	sinusoidal
Battery Voltage	3 V ± 0.1 V

Response Time (after manual range selection)

Measured Quantity / Measuring Range	Digital Display Response Time	Measured Quantity Jump Function
V $\overline{\text{---}}$, V \sim , A $\overline{\text{---}}$, A \sim	1.5 s	from 0 to 80% of the measuring range upper limit
30 Ω ... 3 M Ω	2 s	from ∞ to 50% of the measuring range upper limit
30 M Ω	5 s	
Continuity	< 50 ms	
\rightarrow	1.5 s	
$^{\circ}\text{C}$ (Pt100/Pt1000)	max. 3 s	
30 nF ... 300 μF	max. 2 s	from 0 to 50% of the measuring range upper limit
>10 Hz	max. 1.5 s	

Display

LCD window (95 mm x 40 mm) with analog and digital display, including display of unit of measure, current type and various special functions.

Type COG (chip on glass) for good legibility from various directions

Background Illumination

Background illumination (by means of LEDs) is activated with two keys, and is switched off automatically after approximately 1 minute.

Analog:

Display LCD scale with pointer

Scale length 80 mm for V $\overline{\text{---}}$ and A $\overline{\text{---}}$;

67 mm for all other ranges

Scaling \mp 5 ... 0 ... \pm 30 with 35 scale graduations for $\overline{\text{---}}$,
0 ... 30 with 30 scale graduations for all other ranges

Polarity Display with automatic switching

Overload Display triangle appears

Sampling Rate 20 measurements per second

Digital:

Display/Char. Height 7 segment characters / 20 mm

Number of Places $4\frac{3}{4}$ -place \cong 31000 steps

Overload Display "OL" appears

Polarity Display "-" is displayed if plus pole is connected to \perp jack

Sampling Rate 2 measurements per second

Display Refresh Rates

V $\overline{\text{---}}$ (DC), V \sim (AC), A, Ω , \rightarrow ,

$^{\circ}\text{C}$ (Pt100, Pt1000) twice per second

Hz once per second

Power Supply

Batteries 2 ea. 1.5 V cells (4 x AA size)
alkaline-manganese per IEC LR6

Service Life with alkaline-manganese batteries: approx. 100 hours
Battery Test Battery capacity display with battery symbol in 4 segments: "

Battery Saving Circuit

The instrument is switched off automatically

- if the measured value remains unchanged for a period of approximately 10 minutes, and if none of the control elements are operated during this period. Automatic shutdown can be disabled.
- If battery voltage drops to below approx. 1.8 V

Fuses

300 μ A to 10 A range - Resettable 15A/240VAC/50VDC miniature circuit breaker,
- A fuse link is additionally connected in series to the auto-fuse, the blowing or absence of which is detected automatically ("FUSE" is displayed):
T16A/500VAC, 6,3 mm x 32 mm
Switching capacity 1.5 kA at 500 V AC and ohmic load

Electrical Safety

Safety Class II per IEC/EN 61010-1:2010/VDE 0411-1:2011
Measurement Category CAT II
Operating Voltage 300 V
Pollution degree 2
Test Voltage 2.3 kV~ per IEC/EN 61010-1:2010/VDE 0411-1:2011

Electromagnetic Compatibility (EMC)

Interference Emission EN 61326-1:2006 Class B
Interference Immunity EN 61326-1:2006
EN 61326-2-1:2006

Ambient Conditions

Accuracy range 0 °C ... +40 °C
Operating Temp. -10 °C ... +50 °C
Storage Temperature -25 °C ... +70 °C (without batteries)
Relative Humidity max. 75%, no condensation allowed to 2000 m
Elevation
Deployment indoors, outdoors: only within the specified ambient conditions

Mechanical Design

Protection housing: IP 40, connector jacks: IP 20
Table Excerpt Regarding Significance of IP Codes

IP XY (1 st digit X)	Protection against foreign object entry	IP XY (2 nd digit Y)	Protection against the penetration of water
2	≥ 12.5 mm dia.	0	not protected
4	≥ 1.0 mm dia.	0	not protected

Dimensions 146 mm x 118 mm x 44 mm
Weight approx. 450 gr. with batteries



Attention!

Disconnect the instrument from the measuring circuit before opening to replace batteries or fuses!

16.1 Batteries

Make sure that no battery leakage has occurred before placing your instrument into service for the first time, or after long periods of storage. Repeat this inspection on a regular basis thereafter.

If battery leakage has occurred, clean the electrolyte from the device completely and carefully with a dampened cloth and install new batteries before placing the instrument back into service.

If the „“ symbol appears at the display, replace the batteries as soon as possible. The instrument requires two 1.5 V batteries in accordance with IEC R 6 or IEC LR 6.

Replacing the Batteries



Attention!

Disconnect the instrument from the measuring circuit at all poles before opening the battery compartment!

- ⇒ Fold the instrument closed.
- ⇒ Insert a coin or a similar object into the slot between the housing and the battery compartment cover and press down until the battery compartment cover snaps open.
- ⇒ Fold the instrument open as far as it will go and remove the battery compartment cover.
- ⇒ Insert two 1.5 V mignon batteries per IEC R6 or IEC LR6 into the battery compartment, making sure they are poled in accordance with the symbols.
- ⇒ Replace the battery compartment cover and press into position until it audibly snaps into place.
- ⇒ Please dispose of depleted batteries in an environmentally sound fashion!

16.2 Fuses

Eliminate the cause of overload after a fuse or breaker is tripped before placing the instrument back into service!

10 A Range

A humming sound originating from the 15 A circuit breaker is normal when measuring high value alternating current.

If the miniature 15 A circuit breaker for the active current measuring range is tripped, FUSE appears at the digital display and an acoustic signal is generated simultaneously. Make sure that the red pin is popped out in the tripped condition, i.e. that no adhesion or fusion has taken place. Short circuit the Ω and 15 A jacks with the selector switch set to the continuity test position, and “DL” must appear at the display.



Attention!

Inspect the measuring circuit and eliminate the cause of overload before activating the reset button at the miniature circuit breaker.

The fuse link connected in series to the auto-fuse may only be replaced by authorized service personnel.

16.3 Housing / Opening of Equipment / Repair

No special maintenance is required for the housing. Keep outside surfaces clean. Use a slightly dampened cloth for cleaning. Avoid the use of cleansers, abrasives or solvents.

The equipment may be opened only by authorized service personnel to ensure the safe and correct operation of the equipment and to keep the warranty valid.

Even original spare parts may be installed only by authorized service personnel. In case the equipment was opened by unauthorized personnel, no warranty regarding personal safety, measurement accuracy, conformity with applicable safety measures or any consequential damage is granted by the manufacturer.

16.4 Device Return and Environmentally Compatible Disposal

The instrument is a category 9 product (monitoring and control instrument) in accordance with ElektroG (German Electrical and Electronic Device Law). This device is subject to the RoHS directive. Furthermore, we make reference to the fact that the current status in this regard can be accessed on the Internet at www.gossenmetrawatt.com by entering the search term WEEE.

We identify our electrical and electronic devices in accordance with WEEE 2012/19EU and ElektroG with the symbol shown to the right per DIN EN 50419.

These devices may not be disposed of with the trash. Please contact our service department regarding the return of old devices.



If you use batteries or rechargeable batteries in your instrument or accessories which no longer function properly, they must be duly disposed of in compliance with the applicable national regulations.

Batteries or rechargeable batteries may contain harmful substances or heavy metal such as lead (Pb), cadmium (Cd) or mercury (Hg).

The symbol shown to the right indicates that batteries or rechargeable batteries may not be disposed of with the trash, but must be delivered to collection points specially provided for this purpose.



Pb Cd Hg

17 Multimeter Messages

Message	Function	Significance
FUSE	Current measurement	Blown fuse or tripped miniature circuit breaker
	In all operating modes	Battery voltage less than 2.3 V
OL	In all measuring modes	Indicates overload

18 Repair and Replacement Parts Service Calibration Center* and Rental Instrument Service

When you need service, please contact:

GMC-I Service GmbH
Service-Center
Thomas-Mann-Str. 20
90471 Nürnberg • Germany
Phone +49 911 817718-0
Fax +49 911 817718-253
E-Mail service@gossenmetrawatt.com
www.gmci-service.com

This address is only valid in Germany.

Please contact our representatives or subsidiaries for service in other countries.

* DAkkS Calibration Laboratory for Electrical Quantities D-K-15080-01-01 accredited per DIN EN ISO/IEC 17025:2005

Accredited measured quantities: direct voltage, direct current values, DC resistance, alternating voltage, alternating current values, AC active power, AC apparent power, DC power, capacitance, frequency and temperature

19 Product Support

When you need support, please contact:

GMC-I Messtechnik GmbH
Product Support Hotline
Phone +49 911 8602-0
Fax +49 911 8602-709
E-Mail support@gossenmetrawatt.com

DAkkS Calibration Certificate Reprints

If you order a DAkkS calibration certificate reprint for your instrument, please provide us with the reference numbers indicated in the upper and lower most fields of the calibration mark. We do not need the instrument's serial number.

Edited in Germany • Subject to change without notice • A pdf version can be found on the internet

 **GOSSEN METRAWATT**

GMC-I Messtechnik GmbH
Südwestpark 15
90449 Nürnberg • Germany

Telefon+49 911 8602-111
Telefax +49 911 8602-777
E-Mail info@gossenmetrawatt.com
www.gossenmetrawatt.com