

Test system for MIL-STD 461 D/E/F/G CS 114 /115 /116



TABLE OF CONTENTS

1.	Test setup description.....	2
1.1	Introduction.....	2
1.2	Calibration setup	3
1.3	Injected perturbations	3
1.4	Tabletop and rack-mounted solutions	5
2.	CS116 damped sinusoidal pulse generator.....	6
3.	Equipment for CS114, CS115 and CS116 testing.....	8
4.	Optional CS106 equipment.....	9
5.	Control interface for fully automated system.....	10
6.	Accessories.....	13
7.	Services	14
8.	Technical specifications.....	14

1. Test setup description

1.1 INTRODUCTION

Montena's fully automated test setup for MIL-STD 461 CS 114 + 115 + 116 comprises following elements:

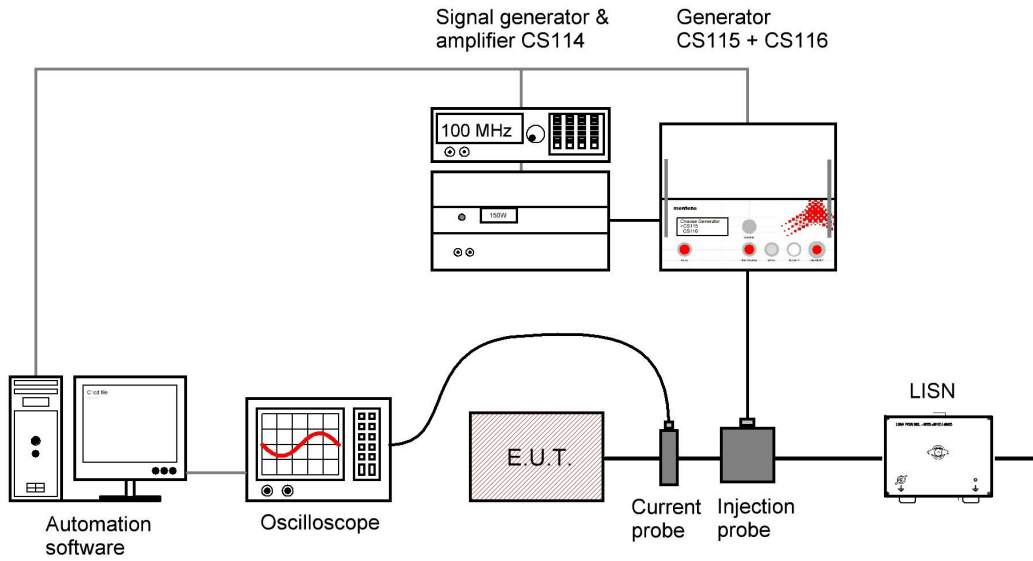

Figure 1: combined test setup for CS114, CS115 & CS116

The test generator is connected to the current injection probe. The generator has one single output for CS115 and CS116 signals. It additionally has an input to receive the CS114 CW signal from the amplifier and drives it directly to the injection probe too.

An oscilloscope connected to a current probe checks the level of the injected perturbation. LISN are to be used to control the impedance on the power line.

A PC with a dedicated control software application allows fully automatic calibration and test sequences, as well as the automatic generation of test reports.

One single signal output

The generator has one signal output only and does therefore not require any change of connections during the test. Thanks to the HF switching capability integrated inside the pulse generator, the whole calibration and measurement procedures can be conducted for the 3 tests without any need to change the cabling. This feature considerably reduces the test duration, the risk of errors due to human mistakes and enables also automated calibration and test sequences.



Figure 2 : signal output (on left side) on the generator's rear panel

1.2 CALIBRATION SETUP

The figure below shows the same setup in the calibration configuration.

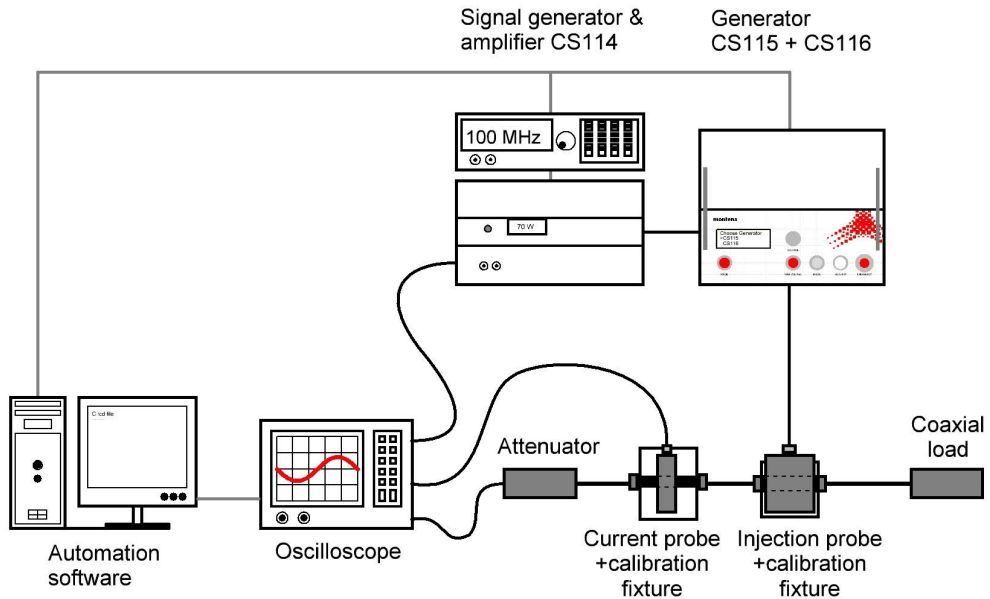

Figure 3 : schematic of a CS 114 + 115 + 116 calibration setup

1.3 INJECTED PERTURBATIONS

CS114 injected signal and level

CS 114 test system delivers the CW signal according to MIL-STD 461 D, E, F and G versions.

In the control software the user can select the test signal level based on the defined curves and table taken from the standards.

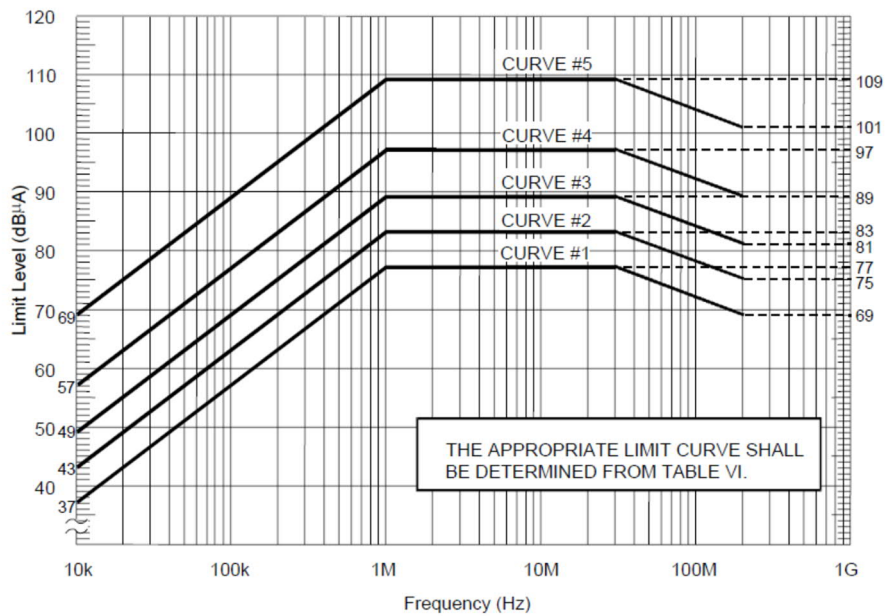

In the automatic mode (software controlled) the system calibration will automatically determine the required generator's output level to obtain the specified current injection level.

CS115 pulse shape and level

CS 115 test system delivers a square pulse according to MIL-STD 461 D, E, F and G versions.

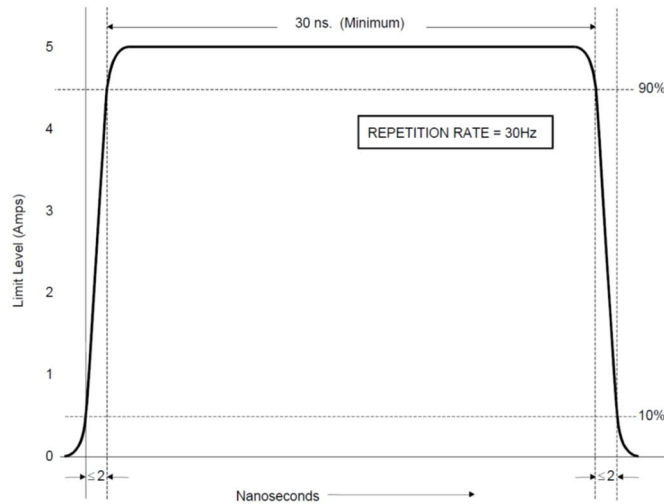
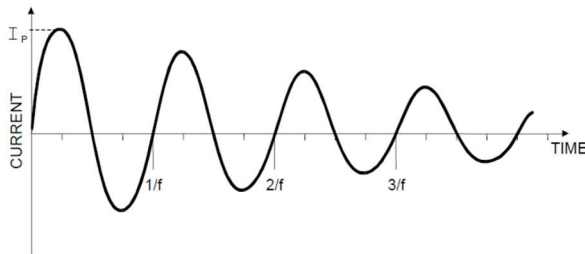

Figure 4 : MIL-STD-461 D/E/F/G CS115 pulse shape

In the automatic mode (software controlled) the current injection level can be defined and the system calibration will automatically determine the required generator's output level to obtain the specified current injection level.

CS116 pulse shape and level

CS 116 test system delivers a damped sinusoidal waveform according to MIL-STD 461 D, E, F and G versions.



NOTES: 1. Normalized waveform: $e^{-(\pi f t)/Q} \sin(2\pi f t)$

Where:

f = Frequency (Hz)

t = Time (sec)

Q = Damping factor, 15 ± 5

2. Damping factor (Q) shall be determined as follows:

$$Q = \frac{\pi(N - 1)}{\ln(I_p/I_N)}$$

Where:

Q = Damping factor

N = Cycle number (i.e. $N = 2, 3, 4, 5, \dots$)

I_p = Peak current at 1st cycle

I_N = Peak current at cycle closest to 50% decay

\ln = Natural log

3. I_p as specified in Figure CS116-2

Figure 5 : MIL-STD-461 D/E/F/G CS116 waveform shape

The damped sinusoidal waveform level can be manually tuned to obtain the required current injection level.

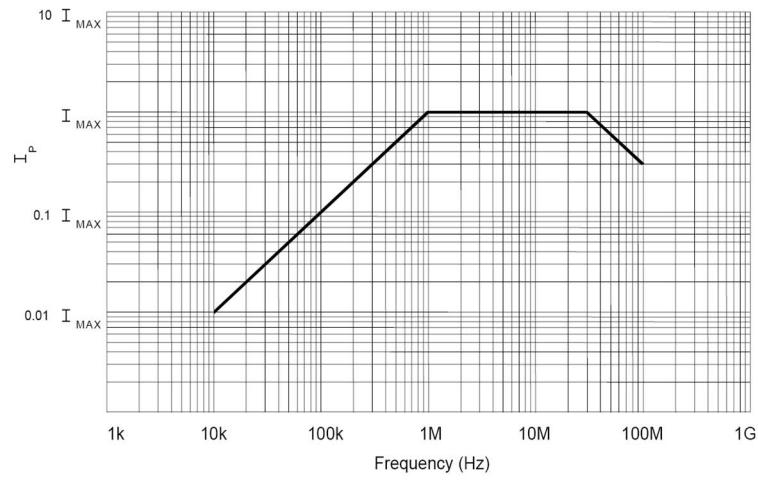

Note: in the MIL-STD 461 D&E versions, two levels are defined with

1. For Army and Navy procurements, I_{MAX} = 10 amperes
2. For Air Force procurements, I_{MAX} = 5 amperes

Figure 6 : MIL-STD-461 D/E/F/G CS116 pulse current level

In the automatic mode (software controlled) the current injection level can be defined for each available discrete frequency and the system calibration phase will automatically determine the required generator output level to obtain the specified current injection level.

1.4 TABLETOP AND RACK-MOUNTED SOLUTIONS

Montena CS114 / CS115 / CS116 test system + optional CS106 / CS101 and RS101 extensions is available in tabletop or 19" rack-mounted solution.

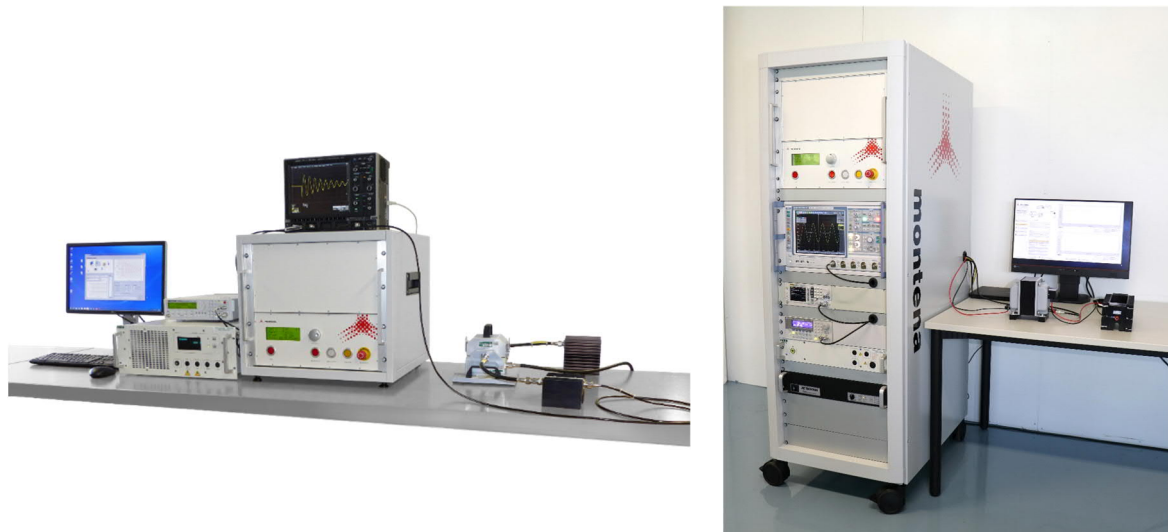

Figure 7 : examples of tabletop and rack-mounted solutions

2. CS116 damped sinusoidal pulse generator

The damped sinusoidal generator POG-CS116 can be supplied with 6 to 17 discrete frequencies.



Figure 8: Montena pulse generator for CS 116 test

Menu driven control panel

The menu driven control panel allows the user to select the desired discrete frequency, the pulse voltage level, the repetition rate and the number of pulses to be generated.

>Set : 70.0% 1325 V	Voltage set in % of maximum level and measured value
Rate: 0.5 pps	Repetition rate (single, 0.5 and 1 pps)
Freq: 1 MHz	Frequency
Time: 00:00 05:00 L	Test duration (actual time set time)



From 6 to 17 frequencies

The MIL-STD 461 D, E, F & G CS116 test method requires testing the susceptibility of the device under test at 6 discrete frequencies (in bold in the table) between 10 kHz and 100 MHz.

Montena's CS116 generator provides additional test frequencies too:

OSCILLATION FREQUENCY	MAXIMAL CURRENT ¹⁾	POG-CS116 - 6	POG-CS116 - 9	POG-CS116 - 17
10 kHz	0.1 A	x	x	x
18 kHz ²⁾	0.2 A			x
30 kHz ²⁾	0.3 A		x	x
56 kHz ²⁾	0.6 A			x
100 kHz	1 A	x	x	x
180 kHz ²⁾	2 A			x
300 kHz ²⁾	3 A		x	x
560 kHz ²⁾	6 A			x
1 MHz	10 A	x	x	x
1.8 MHz ²⁾	10 A			x
3 MHz ²⁾	10 A		x	x
5.6 MHz ²⁾	10 A			x
10 MHz	10 A	x	x	x
18 MHz ²⁾	10 A			x
30 MHz	10 A	x	x	x
56 MHz ²⁾	5.5 A			x
100 MHz	3 A	x	x	x

¹⁾ At 100 % voltage setting and with a 2 m 50 Ω coaxial cable, with the dedicated injection probe (e.g. Prâna IP-DR250) and calibration jig, on the 100 ohm calibration load.

²⁾ These frequencies are not required by the MIL-STD 461 but we recommend them for a better coverage of the frequency range.

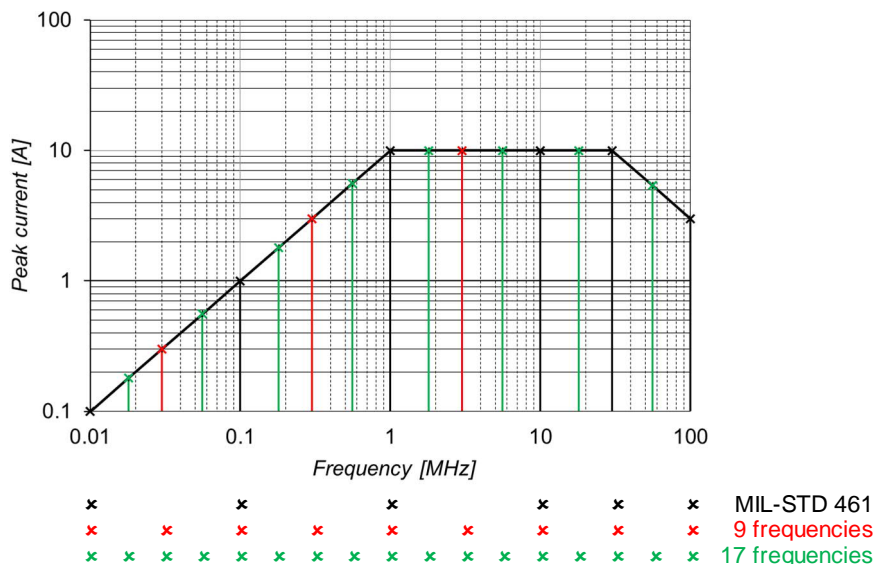

Figure 9: available CS116 test frequencies

In the 9 or 17 frequencies version, the test frequencies are evenly distributed between 10 kHz and 100 MHz for better coverage of potential system resonances.

In some cases, it is very interesting to be able to test the susceptibility of the equipment with some in-between frequencies which will be present in the real deployment and will threaten the equipment's performances. Optionaly montena can provides some additional discrete frequencies anywhere in the range comprised between 10 kHz and 100 MHz.

3. Equipment for CS114, CS115 and CS116 testing

POS.	ITEM	QUANTITY
1	Pulse generator CS116 – one of the below options	
	Montena POG-CS116-6	
1.1	Pulse generator for MIL-STD 461 D/E/F/G CS116, 6 test frequencies, 19" rack version	1
	Montena POG-CS116-9	
1.2	Pulse generator for MIL-STD 461 D/E/F/G CS116, 9 test frequencies, 19" rack version	0
	Montena POG-CS116-17	
1.3	Pulse generator for MIL-STD 461 D/E/F/G CS116, 17 test frequencies, 19" rack version	0
2	19" housing and cabinet rack - one of the below options	
	Montena HOUSING-9U	
2.1	Instrument case for standalone use of the POG-CS116 generator, 9HU, 520mm	1
2.2	19-inch cabinet rack on wheels, height: 173cm, for CS 114 /115 /116 equipment	0
3	Pulse generator CS115 – one of the below options	
	Montena M-CS115	
3.1	Module for MIL-STD 461 D/E/F/G CS115, to be inserted in POG-CS116 generator	1
	Montena PG-CS115	
3.2	Standalone pulse generator for MIL-STD 461 D/E/F/G CS115, for rack 19" or tabletop use.	0
4	CS114 signal generator and amplifier	
4.1	RF Signal generator	1
4.2	Power amplifier 75W, 9 kHz - 400 MHz, with integrated directional coupler	1
5	Injection probe	
	Prana IPDR-250	
5.1	Injection probe 10 kHz – 400 MHz, 500 W, internal diameter : 43 mm	1
	Prana CJDR-250	
5.2	Calibration jig for the injection probe IPDR-250	1
6	Test control & monitoring, and accessories	
6.1	Set of current probe and calibration jig	1
6.2	Set of coaxial load and attenuators	1
6.3	500 MHz, 2 channels oscilloscope, with FFT	1
6.4	Montena control software package for CS115 and CS116	1
6.5	Montena SMARTImmun software application for CS114	1

4. Optional CS106 equipment

It is possible to extend the system to additionally perform pulse injection test according to the CS106 method.

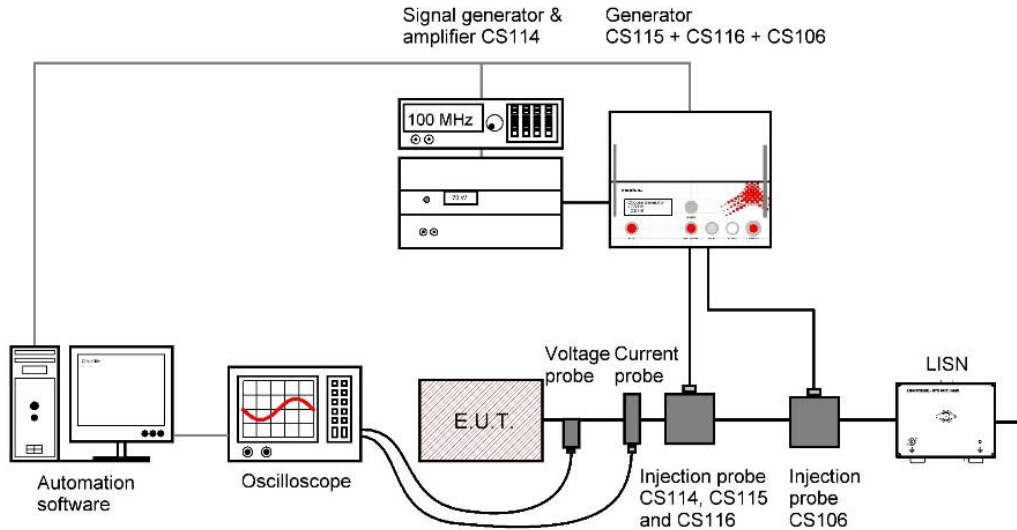

Figure 10 : Combined test setup for CS106, CS114, CS115 & CS116

Because of the low frequency content and high amplitude of the CS106 pulse, it is not possible to use the same injection probe as already utilized for the CS114, CS115 and CS116.

CS106 pulse shape and level

CS106 setup delivers a pulse according to MIL-STD 461 F version.

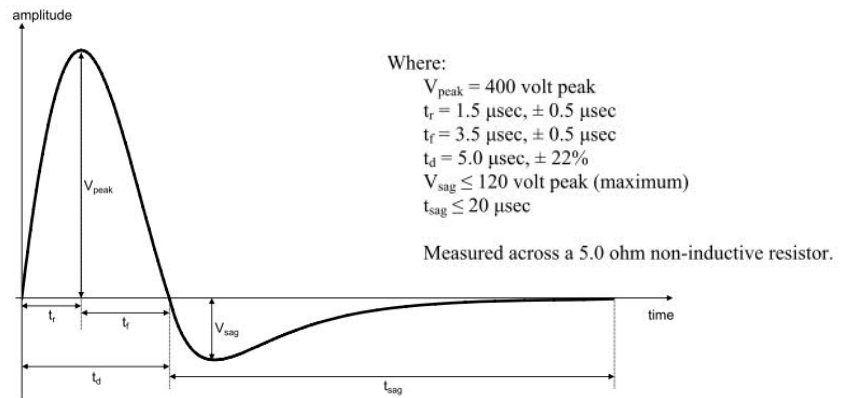

Figure 11 : MIL-STD 461 F CS106 pulse shape

The proposed additional equipment required for CS106 test comprises:

POS.	ITEM	QUANTITY
7	CS116 option	
7.1	Montena M-CS106 Module for MIL-STD 461 F CS106, embedded in POG-CS116 generator	1
7.2	Montena IC10M Injection probe for MIL-STD 461 CS106, aperture 34 x 43 mm	1
7.3	Montena R5-2-400 Precision resistor 5 ohm for MIL-STD 461, CS106 calibration setup	1
7.4	Differential voltage probe	1
7.5	Montena control software application for CS106	1

5. Control interface for fully automated system

The CS 114 /115 /116 test setup from montena is supplied with dedicated control software applications which comprise :

- A **main** panel to select the desired tests to be performed;
- A **calibration** panel allowing a fully automated calibration of the system;
- A **test** panel enabling a fully automated measurement process with sequential injection of the defined current level according to the selected test standard and calibration results;
- A **report generation** to keep track of all measurements and calibration values.

Calibration panel - main features

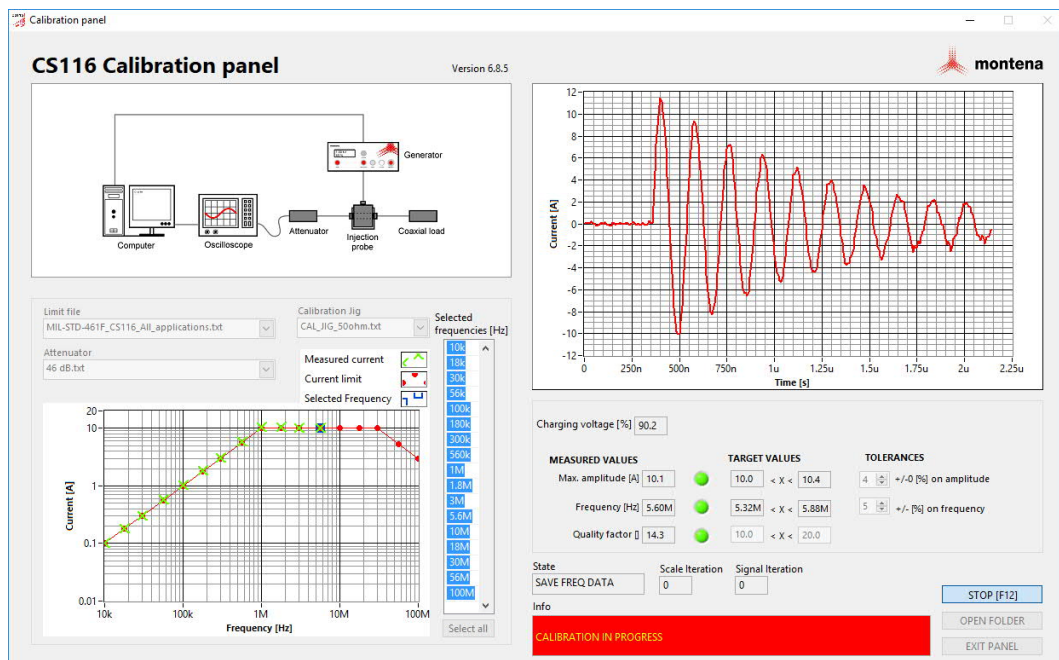

Figure 12 : example of calibration panel

In order to ease the system calibration procedure, the control software provides:

- A selection of the standard to apply (limit files);
- An integration of the measurement correction factors (calibration values of the resistor, factors of the injection probe, attenuators, ...);
- A selection of the frequencies to be applied;
- An automatic calibration procedure: for each frequency -> slowly increase the generator loading voltage until the desired injected current is obtained -> record generator setting -> switch to next frequency ->;
- Automatic configuration of the oscilloscope;
- Display of the injected pulses;
- Automatic edition of a system calibration report.

Test panel - main features

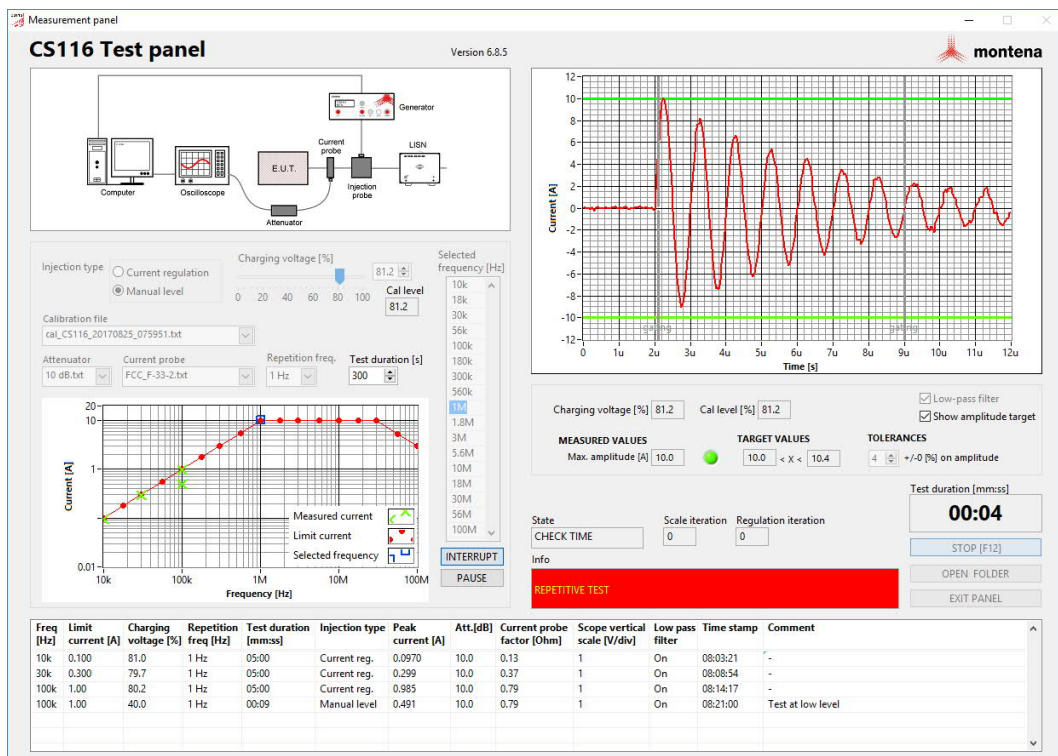

Figure 13 : example of measurement panel

In order to ease the test procedure, the control software provides:

- A selection of the values to be applied (in the form of a system calibration results file);
- An integration of the correction factors and attenuators;
- An automatic measurement procedure: for each frequency-> increase the generator output signal until the value of calibration file is reached -> switch to next frequency ->;
- Automatic configuration of the oscilloscope;
- Display of the test progress;
- A test report generation.

TEST PROCEDURE SUMMARY

With montena test setup and automation software, the operator only has to:

1. Build the calibration setup according to the schematic displayed on the calibration panel;
2. Select the standard to apply (i.e. MIL-STD 461G CS116, ...);
3. Select the probes and attenuators factors (Probexxx_SNxxxxx.txt, ...);
4. Automatically calibrate the system:
Press once "Start Calibration"
5. Generate the calibration report;
6. Build the test setup according to the schematic displayed on the test panel;
7. Select the system calibrated data to apply (i.e. Cal_CS116_01Jan2021.txt)
8. Select the probes and attenuators factors
9. Apply all test frequencies sweeping :
Press once "Start Measurement"
10. Generate the test report.

- ✓ **Automatic calibration for the whole test frequency range**
- ✓ **Application of all test frequencies automatically, level can be selected or automatic**
- ✓ **NO need to manually configure the measurement equipment**
- ✓ **NO need to manually integrate the transfer function of probes and attenuators**
- ✓ **Generation of test reports, NO need to record all values read from the measurement equipment**
- ✓ **Generation of calibration reports, NO need to record all calibration setting parameters.**

6. Accessories

Injection probes with calibration jig

One single injection probe is required for the CS114, CS115 and CS116 tests. For the system calibration phase, the current injection probe is calibrated with help of a calibration jig, an attenuator and a 50 ohm termination load.

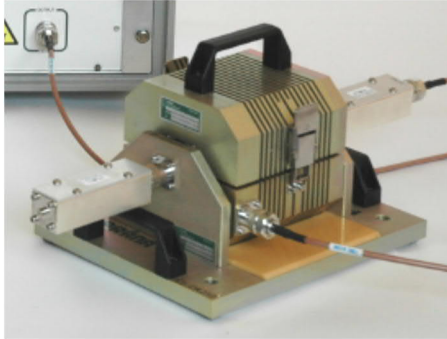

A second injection probe (montena IC10M) is needed for the CS106 test.

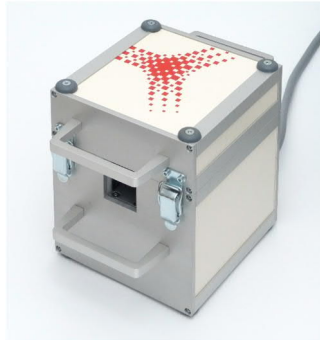

LISN

LISN's (Line Impedance Stabilisation Network) are used to provide standardised impedance in common mode to the power lines connected to the device under test. This allows a better reproducibility of the tests.

The proposed LISN's have the following specifications:

- 150 kHz – 100 MHz
- 50 Ω // 50 μ H
- 1 x 20 A
- 250 Vac 50 Hz, 140 Vac 400 Hz

7. Services

Onsite installation and training

Montena provides onsite installation and training performed by either an engineer from montena or by a local authorized representative support engineer.

A training session is usually given directly after installation. This training includes both the system installation and the test procedure.

Maintenance

No periodic maintenance is required other than a calibration of the measurement equipment.

8. Technical specifications

Technical specifications of the CS116 pulse generator

SPECIFICATIONS			
Type	POG-CS116-6	POG-CS116-9	POG-CS116-17
Test frequencies	10, 100 kHz 1, 10, 30, 100 MHz	10, 30, 100, 300 kHz 1, 3, 10, 30, 100 MHz	10, 18, 30, 56, 100, 180, 300, 560 kHz 1, 1.8, 3, 5.6, 10, 18, 30, 56, 100 MHz
Standard	MIL-STD 461 D / E / F / G , CS116		
Output waveform	damped oscillatory wave		
Output current	10 A on 100 ohm (depends on the frequency)		
Output impedance	< 100 ohm		
Damping factor	15 +/- 5		
Repetition rates	single, 0.5 Hz, 1 Hz		
Output signal connection	N 50 ohm		
Power rating	90 - 250 Vac / 50 - 60 Hz / 35 W / 75 VA		
Storage / operating temperatures	5 - 50 °C / 20 - 45 °C		
Generator weight	complete unit: 34.5 kg / 19-inch rack only: 17.0 kg		
Dimensions (L x W x H)	630 x 530 x 485 mm / 19-inch rack only: 630 x 485 x 405 mm (9HU)		