

GEOHM 5

Earth Tester

3-349-418-03
3/2.11



Meanings of Symbols on the Instrument



Protection class II device



Warning concerning a point of danger
(Attention: observe documentation!)



Warning regarding dangerous electrical voltage



Mark on your equipment certifies that this equipment meets the requirements of the EU (European Union) concerning safety and interference causing equipment regulations



This device may not be disposed of with the trash. Further information regarding the WEEE mark can be accessed on the Internet at www.gossenmetrawatt.com by entering the search term „WEEE“.

© 2009 GMC-I Messtechnik GmbH

No part of this publication may be reproduced or utilized in any form or by any means without permission in writing from GMC-I Messtechnik GmbH.

1	Introduction	4
1.1	General description	4
1.2	Warnings	4
1.3	General settings (first use)	5
1.4	List of parameters measured by the Earth Tester	6
1.5	Standards applied	6
2	Instrument description	7
2.1	Instrument Casing	7
2.2	Front panel	7
2.3	Connector panel	9
2.4	Base	9
2.5	Instrument Messages	10
2.6	Earth Resistance	11
2.6.1	Standard four-lead test method	11
2.6.2	Standard four-lead test method in combination with sensitive test clamp	14
2.6.3	Earth Resistance measurement with two test clamps	16
2.7	Specific Earth Resistance	19
2.8	Current (True RMS)	22
3	Memory and other operations	24
3.1	Memory	24
3.1.1	Storing of test results	25
3.1.2	Recalling of stored results	26
3.1.3	Erasing stored results	28
3.2	RS 232 communication	29
3.3	Reset of the instrument	30
4	Maintenance	31
4.1	Batteries	31
4.2	Cleaning	32
4.3	Recalibration	32
4.4	Service	33
4.5	Device Return and Environmentally Compatible Disposal	33
5	Technical specification	34
5.1	Measurement functions	34
5.2	General characteristics	36
6	Standard accessories	37
6.1	Optional accessories	37
7	Repair and Replacement Parts Service, Calibration Center and Rental Instrument Service	38
8	Product Support	38

1 Introduction

We are very pleased to offer a high quality, professional grade test instrument, for carrying out four wire Earth Resistance measurements, as well as specific ground resistance measurements on which the estimation of earthing quality is based. The equipment was designed and produced based on many years experience of producing and dealing with Earth Resistance and Electric installation test equipment.

1.1 General description

The Earth Tester is a professional, hand-held, battery powered test instrument. It is intended for carrying out Earth Resistance measurements in accordance with International standard IEC 60364-6-61 (VDE 0100 Teil 610) and European standard EN 61557 - 5.

The instrument is supplied with all of the basic accessories necessary for carrying out the tests.

The electronic section of the Earth Tester is produced in SMD technology, which requires practically no service intervention. A custom designed LC display offers easy to read main results as well as subresults, parameters and messages. Application is simple and clear and the operator does not need to attend any special training (except to read this Instruction Manual) to operate the instrument.

1.2 Warnings

In order to ensure operator safety while carrying out various measurements and tests using the Earth Tester, as well as to keep the test equipment undamaged, it is necessary to consider the following general warnings:

- **If the test equipment is used in a manner not specified in this Instruction Manual, the protection provided by the equipment may be impaired!**
- **Do not use the instrument and accessories if any damage is noticed!**
- **Service intervention or calibration procedure must only be carried out by a competent, authorized person!**
- **Never connect the instrument onto high voltage.**
- **Do not charge when alkaline batteries are fitted!**
- **Turn power off and disconnect any measurement accessory connected to the instrument before opening battery cover.**

1.3 General settings (first use)

There is usually voltage or current noise present on the earthing system under test, caused by mains voltage somewhere in the near or far vicinity. Mains voltage frequency is different in different countries (50 Hz in European countries etc., 60 Hz in the United States etc.). In order to get stable test results, regardless of noise levels, it is advisable to insert the nominal frequency of the mains system.

The instrument's measuring system assures excellent noise immunity. In extremely noisy conditions, the stability of results can be further improved by means of averaging. The frequency and algorithm, once set, will stay set, even after replacing batteries.

Insert the frequency of mains voltage (50/60 Hz)

Setting the unit of Specific Earth Resistance parameter ($\Omega\text{m}/\Omega\text{ft}$)

Setting the measuring algorithm

Switch **OFF** the instrument.



Keep **ON** key pressed while switching on the instrument until **Fr** followed by **50** or **60** value (last selected) starts to flash.

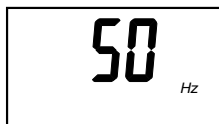
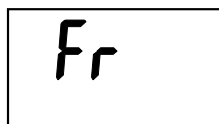

Press **UP/DOWN** key to select appropriate frequency of mains voltage.



Press **START** key to confirm "Frequency". Unit **m** or **ft** (last selected), used in Earth Resistivity measurement, starts to flash.



Select appropriate unit (**m** or **ft**).



Press **START** key to confirm "Unit selection". Measuring algorithm type starts to flash.

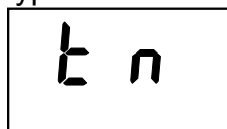

Normal algorithm

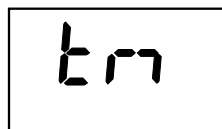

Improved noise rejection algorithm (by means of averaging techniques)



Press **START** key to confirm measuring algorithm. The instrument is ready for regular measurements.



Note:

In general it is recommended to use the 'Normal' measuring algorithm because of the instrument's high intrinsic noise immunity.

If the results are still unstable further improvements can be achieved by averaging eg. selecting the 'Improved measuring algorithm'. However, this prolongs the measuring time significantly (up to 20 seconds).

New selection is also offered after each resetting of the instrument (see the procedure in chapter 3.3. (Reset of the instrument!)).

1.4 List of parameters measured by the Earth Tester

Parameter	Function switch position	Used accessories
Earth Resistance R_E (classic four-lead method)	R_{EARTH}	Four test terminals Two test rods
Selective Earth Resistance R_S (classic four-lead method plus test sensitive clamp)	R_S (clamp)  R_S	Four test terminals Two test rods One sensitive test clamp
Selective Earth Resistance R_E (two test clamps)	R_E (2 clamps)  R_E	Two test clamps
Earth Resistivity ρ	ρ_{EARTH}	Four test terminals Four test rods
Current (True RMS)	I_{CLAMP}	One sensitive test clamp

1.5 Standards applied

Earth Tester is designed in accordance with European safety standard

- EN 61010 – 1

EMC (noise and immunity) in accordance with European standards

- EN 61326-1: 2006

Measurements in accordance with European standard EN 61557-5, Part 5: Earth resistance (EN 61557-5 Earth resistance)

2 Instrument description

2.1 Instrument Casing

The instrument is housed in a plastic casing, which maintains the protection class defined in the general specifications. The casing consists of a main section, which includes the operator's panel and connectors and of a moveable cover.

The cover is permanently fixed to the base section and cannot be detached.

2.2 Front panel

The front panel consists of a custom LCD, a rotary switch, and a keyboard, see the figure below.

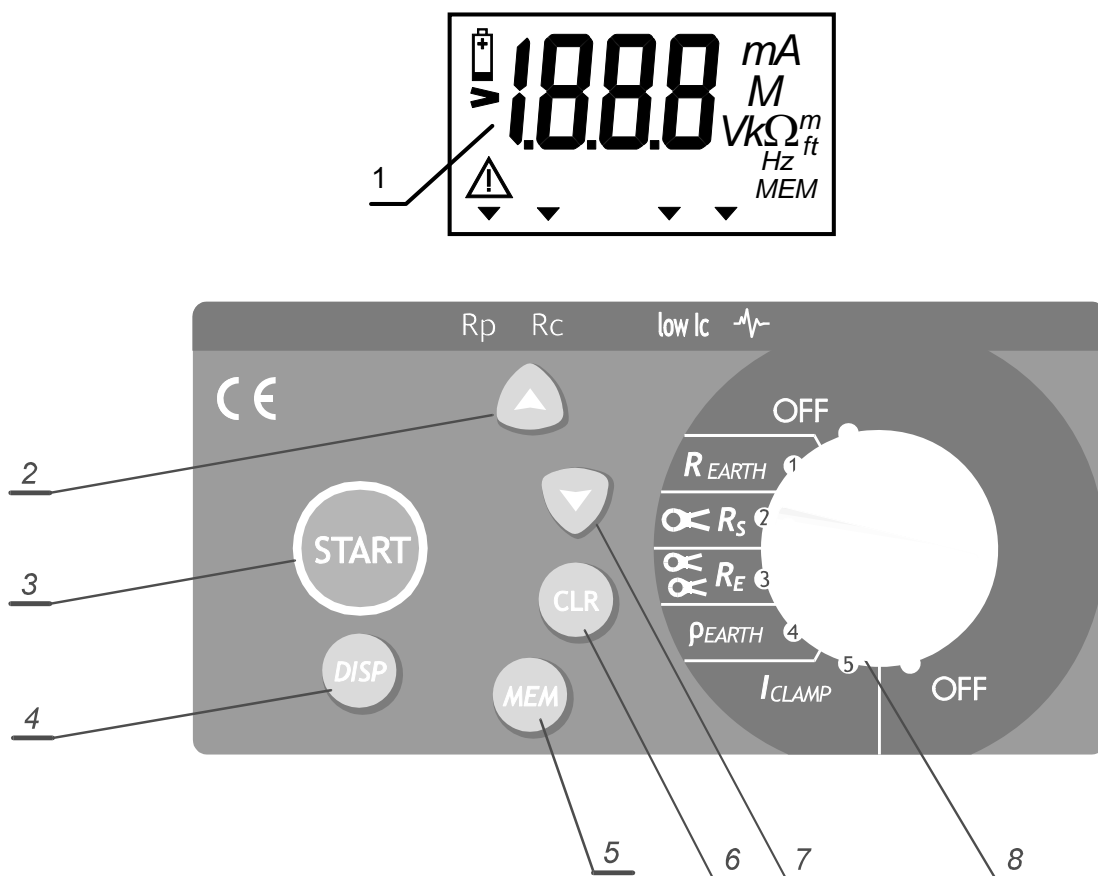

Figure 1. Front panel

Legend:

- 1 Custom designed **LCD**.
- 2 **CURSOR up key** to:
 - Increment storage MEM code.
 - View previous result
 - Set the instrument to general settings
 - Earth resistivity function: Increment the distance »a« between test rods
- 3 **START key** to:
 - Start any measurement.
 - Leave the recall function
 - Cancel save or clear procedure
 - Select/set function parameters in General settings:
 - Earth resistivity unit (Ωm or Ωft)
 - Frequency (50 or 60) Hz.
- 4 **DISP key** to display the subresults of the selected function. (Check current and potential probe resistances (**R_c** and **R_p**) in ρ_{EARTH} , **R_{EARTH}** and $\text{⊗} \leq \text{R}_s$ functions.)
- 5 **MEM key** to store and recall results.
- 6 **CLR key** to erase memorized results and/or reset the instrument
- 7 **CURSOR down key** to:
 - Decrease storage MEM code.
 - View the next result
 - Earth resistivity function: Decrease the distance »a« between test rods
- 8 **Rotary switch** to:
 - Select the measurement function or OFF position. (Auto OFF will occur automatically, 10 minutes after the last strike to any key or function switch rotation.)
 - Cancel, save or clear procedure
 - Exit recall procedure

2.3 Connector panel

- Use original test accessories only!
- Never connect instrument onto high voltage
- Max. continuous current to C1-C2 test terminals is 0,3A!

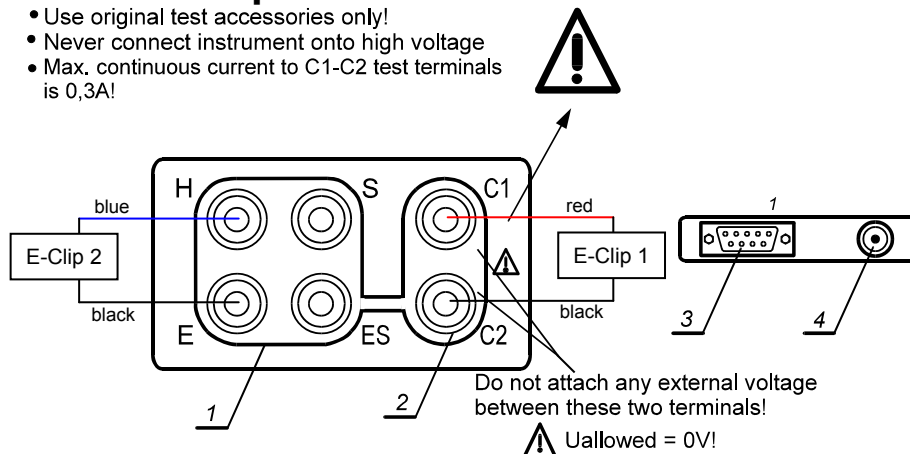

Figure 2. Connector panel

Legend:

- 1 Test terminals:
 - Blue – test terminal H
 - Black – test terminal E
 - Red - test terminal S
 - Green - test terminal ES
- 2 Clamp test terminals C1 and C2
- 3 RS 232 connector (to connect Earth Tester to PC)
- 4 Battery charger connector

The test connector is intended for connection of the test cable and is accessible only when the instrument cover is lifted up. RS 232 and battery charger connectors are accessible only when the cover of the instrument is closed. For safety reasons both connector fields cannot be accessible at the same time, the cover of the instrument selects the accessible one.

2.4 Base

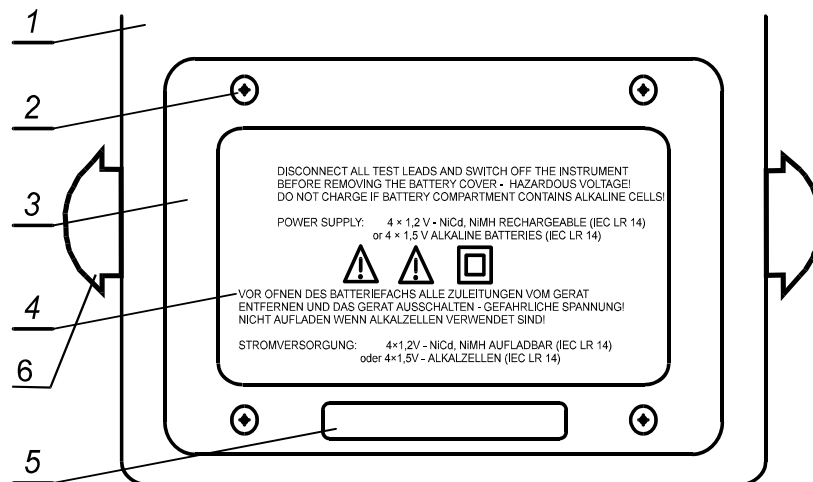

Figure 3. Base

Legend:

- 1 Plastic housing.
- 2 Screw (4 pieces) to fix the battery cover.
- 3 Battery compartment cover.
- 4 Battery cover warnings.
- 5 Trade mark label.
- 6 Plastic holder for carrying strap

2.5 Instrument Messages

Messages are generated on the **LCD** using special symbols and numeric segment combinations. The following figure shows all of the possible display segments and the table beneath describes the messages.

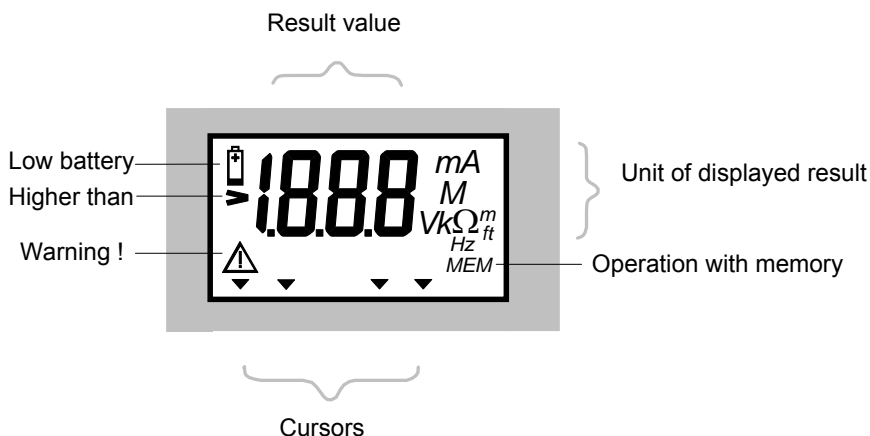

Figure 4. Display segments

Description of possible display messages:

>1999	Result out of range.
v and > 20 V	External voltage is higher than approx. 20 V _{eff} .
v and ▼ on R_C	Current spike resistance is too high
v and ▼ on R_P	Potential spike resistance is too high
v and ▼ on Low I_C	Current tested by clamp is lower than 0,5 mA
v and ▼ on 	Current noise is higher than approx. 2,1 A or / and noise voltage is higher than approx. 5 V
MEM	Operating with storage (store or recall).
no MEM	No stored result to be recalled.
RCL	Recall function entered.
Clr MEM	Confirm or abort clearing of last stored result?
Clr / ALL alternating	Confirm or abort clearing of all stored results?
FUL	All storage locations occupied.
toP	Last stored result on this location – no more results
bot	First stored result on this location – no more results
SEr	Active serial communication.

Fr	General settings – selection of frequency
LEn _m	General settings – selection of unit in Earth Resistivity measurement
t _□ , t _□	General settings – selection of measuring algorithm
	Batteries are too weak – replace the batteries.
rES	*Reset of the instrument (erased memories).

Table 1. Messages

- * This indication appears after the insertion of batteries, i.e. when batteries were removed from the battery compartment for a specific period of time (a few hours), or if the microprocessor detects an irregularity in its memory or if reset of the instrument has been performed. Measurement instructions

Measurements

2.6 Earth Resistance

The Earth Tester is able to carry out Earth Resistance measurement using three different methods. The appropriate one is selected by the operator depending on the particular earthing system to be tested.

Selective Earth Resistances can be measured using test clamp (without mechanical disconnection of tested earthing electrode).

Probeless measurement can be done using two test clamps.

2.6.1 Standard four-lead test method

The four-lead connection gives much better results than the three-lead connection, as there are no problems concerning contact resistance between the test clips and the (usually rusty) surface of the electrode under test.

The distance from the earthing electrode under test to the current measurement probe H is at least 5 times the depth of earthing electrode rod or the length of the band electrode (see Figure 5).

If measuring the total Earth Resistance of a complex earthing system, the required distance depends on the longest (diagonal) distance (d) between the individual earthing electrodes (see Figure 6).

Step 1

- Connect the test leads to the instrument and to the object under test in accordance with the figures below.

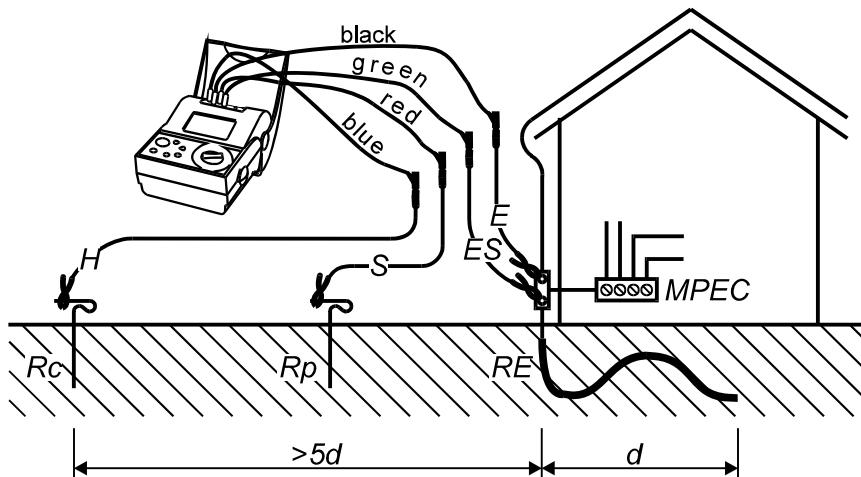

Figure 5. Connection of standard 20 m long test leads

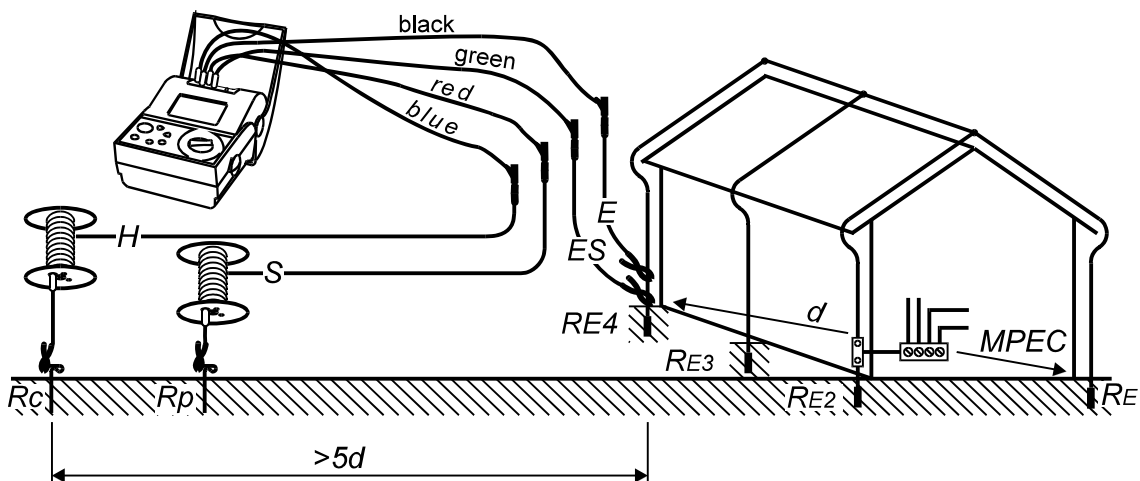

Figure 6. Connection of optional 50 m long test leads

- $R_{Earthtot} = R_{E1} // R_{E2} // R_{E3} // R_{E4}$
- $R_{E1..E4}$separate earthing resistance
- R_Ppotential spike resistance (P= Potenzial)
- R_Ccurrent spike resistance (C= Current)
- $R_{Earthtot}$total earth resistance of tested earthing system
- d probe distance, $d \geq 20 \text{ m} \pm$ tolerance depending on potential gradient

Step 2

- Set the function switch to **R_{EARTH}** position, the following menu will be displayed:

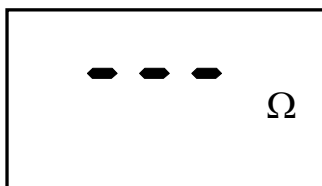

Figure 7. Earth Resistance initial menu

Step 3





Press **START** key and view the test result. (If you want to perform more than one measurement press the **START** key and keep it pressed until the result has stabilized, then release the key. The last result will stay displayed.)



Press the **DISP** key to check the resistances of both the potential (**R_p**), and the current (**R_c**) test probes. After a short period the main result will automatically be displayed again.

- Store the displayed result for documentation purposes, see instructions on how to use memory in chapter 3.1.1. Storing of test results.

Notes!

- When an external voltage higher than 20 Vac/dc. is present between H and E or ES and S test terminals, the Earth Resistance measurement will not be carried out after pressing **START** key, but the message **> 20 V** will be displayed, marked with  symbol!
- If a noise voltage higher than approx. 5 V is present between the H and E or ES and S test terminals, a cursor mark pointing to the “” (noise) symbol will be displayed, indicating that the test result may not be correct!
- If the resistance of the current or potential rod is too high ($>(4 \text{ k}\Omega + 100 R_E)$ or $>50 \text{ k}\Omega$, whichever is lower), then the test result will be marked with ν symbol and the cursor will appear on **R_c** and / or **R_p**.
- If the test result is out of measurement range (open test leads), **>19,99 kΩ** message will be displayed!

2.6.2 Standard four-lead test method in combination with sensitive test clamp

Measuring selective earth resistance (test clamp E-Clip 1)

If several earthing electrodes are connected in parallel (see figure 8), then it is very important to know the quality of each individual electrode. This is especially important when the earthing system is intended for protection against atmospheric discharging, because any inductance within the earthing system presents a potential danger (due to increased resistance to high frequency pulses during the atmospheric discharge).

In order to test each electrode separately, they should be mechanically separated, but the mechanical connections are usually very difficult to disconnect because of corroded connection components (screws, nuts, spacers, etc.).

The main advantage of the selective measurement method with clamp is that there is no need to mechanically disconnect the electrode under test.

Step 1

Connect test leads and sensitive test clamp (E-Clip 1) to the instrument and to the object under test in accordance with the figure below.

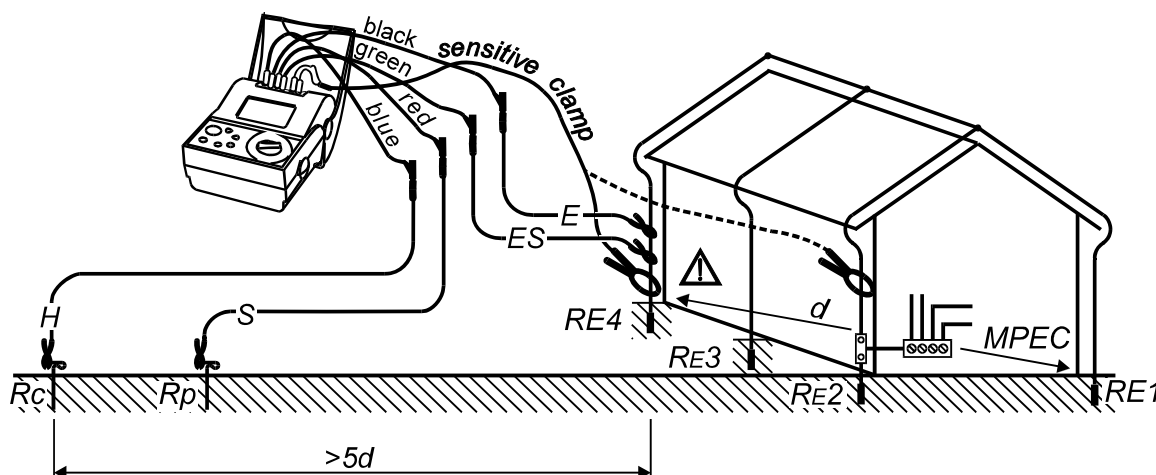

Figure 8. Connection of standard 20 m long test leads and sensitive test clamp (E-Clip 1)

⚠...Ensure that the test sensitive test clamp (E-Clip 1) is connected under the E test terminal, otherwise the parallel resistance of all other electrodes (R_{E1} up to R_{E4}) will be measured!

$$R_S = \frac{U}{I_{clamp}} = R_{E4}$$

R_{E4}selective earthing resistance of electrode E4

U.....test voltage

I_{clamp}the current measured by sensitive test clamp

R_Sselective earth resistance

d.....probe distance, $d \geq 20 \text{ m} \pm$ tolerance depending on potential gradient

Step 2

Set function switch to “ R_s ” position, the following menu will be displayed.

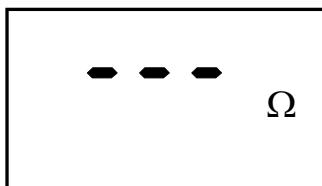

Figure 9 Earth Resistance initial menu

Step 3





Press **START** key and view the test result. (If you want to perform more than one measurement press the **START** key and keep it pressed until the result has stabilized, then release the key. The last result will stay displayed.)



Press the **DISP** key to check the resistances of both the potential (**R_p**), and the current (**R_c**) test probes. After a short period the main result will automatically be displayed again.

- Store the displayed result for documentation purposes, see instructions how to use memory in chapter 3.1.1. Storing of test results.

Notes!

- When an external voltage higher than 20 Vac/dc. is present between the H and E or ES and S test terminals, the Earth Resistance measurement will not be carried out after pressing **START** key, but the message **> 20 V** will be displayed, marked with  symbol!
- If a noise voltage higher than approx. 5 V is present between the H and E or ES and S test terminals, a cursor mark pointing to the “” (noise) symbol will be displayed, indicating that the test result may not be correct!
- If the resistance of the current or the potential rod is too high ($>(4 \text{ k}\Omega + 100 \text{ RE})$ or $>50 \text{ k}\Omega$, whichever is lower), the test result will be marked with ν symbol and the cursor will appear on **R_c** and / or **R_p**.
- If the test result is out of the measurement range (open test leads), **>19,99 kΩ** message will be displayed!
- If the current measured with the sensitive test clamp is lower than 0,5mA, the cursor will appear on **Low I_c** (low current), indicating that the test result may not be correct!
- This can happen if measuring a large lightning system or in cases of high current rod resistance.

- If noise current higher than approx. 2,1 A is present in the clamp loop, a cursor mark pointing to the “~” (noise) symbol will be displayed, indicating that the test result may not be correct! The value of noise current may be also measured in the **CURRENT** function, see chapter 2.8.

2.6.3 Earth Resistance measurement with two test clamps

The two clamp principle enables you to perform rodless measurements. Examples of use are in built up areas where it may be difficult or impossible to drive test probes into the ground and measurements of complex earthing systems (see figure 8). The advantage of this principle is that there is no need to drive measurement probes in or to separate the measured electrodes.

Equivalent electrical circuit diagram of Figure 10 is presented on the figure below.

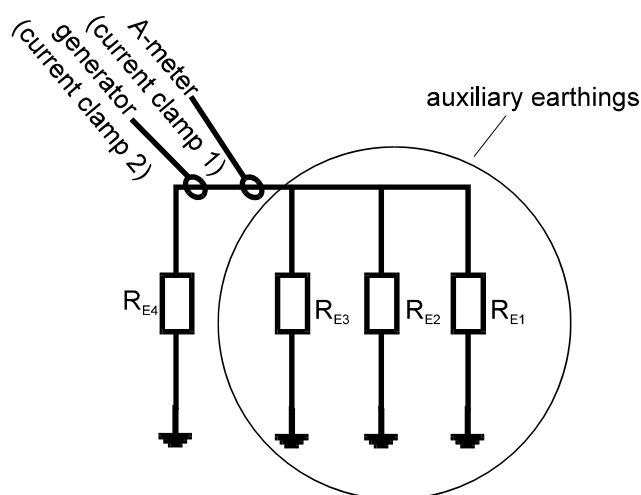

Figure 10 Equivalent electrical circuit diagram

If the total Earth Resistance of the parallel connected electrodes R_{E1} , R_{E2} , and R_{E3} is much lower than the resistance of the tested electrode R_{E4} , then the following result can be recorded.

$$R_{\text{result}} = R_{E4} + (R_{E1} // R_{E2} // R_{E3}) \approx R_{E4}$$

This is a good approximation of selective resistance R_{E4} .

Other specific resistances can be measured by moving the test clamps to other electrodes

Step 1

- Connect test clamps to the instrument and to the object under test in accordance with the figure below (test clamps must be at least 30 cm apart).

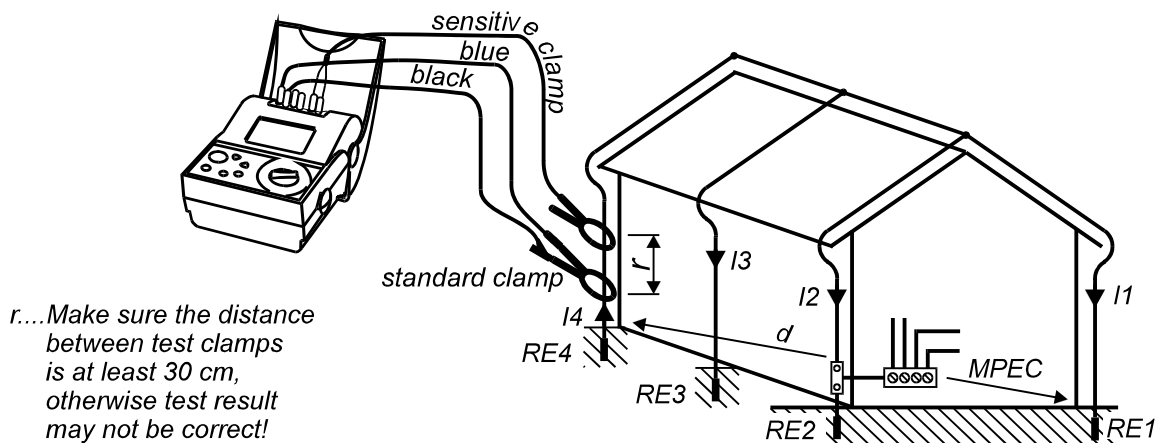

Figure 11.. Connection of two test clamps

Step 2

- Set function switch to “ RE” position, the following menu will be displayed:

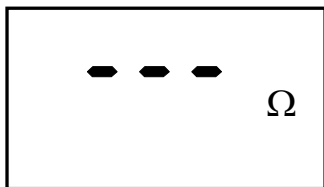

Figure 12. Earth Resistance initial menu

Step 3

- The measurement commences (constant measurement), results are continuously displayed.
- Last result will stay displayed.
- Store the displayed result for documentation purpose, see instructions how to use memory in chapter 3.1.1. Storing of test results.

Notes!

- If the test result is out of the measurement range (e.g. open test leads), **>99,9 Ω** message will be displayed!
- If the current, measured with the sensitive test clamp, is lower than 0,5 mA, the cursor will appear on **Low I_c** (low current), indicating that the test result may not be correct!
- If the ratio of **Noise current / Measurement current** > 100 or $I_{\text{noise}} > 2,1 \text{ A}$, a cursor mark pointing to the “ ν ” (noise) symbol will be displayed, indicating that the test result may not be correct! The value of noise current may be also measured in the **CURRENT** function.
- Connect the sensitive test clamps (E-CLIP 1) to the C1/C2 test terminals, and the standard test clamps (E-CLIP 2) to E/H test terminals.
- If using a generator clamp other than a recommended, it is necessary to compensate its impact on the measured results. In this instance use the following procedure.
- To improve measurement results when using third party clamps, it is possible to reduce the test current. However the accuracy in this instance is not guaranteed.

Procedure for adjusting non original clamp (if used as generator clamp).

Using a clamp other than that a recommended could seriously impact on the measured results (due to different coil inductivities).

It is possible to compensate for this effect when using 1/1000 current clamps from another supplier.

Compensation procedure for non-original clamp:

1. The clamp must have same electrical specification as E-CLIP 2:
current ratio: (1000 A / 1 A)
input current range: 1000 A
1. Perform reset of the instrument (see instructions in chapter 3.3 Reset of the instrument).
2. The compensation must be performed on a 10 Ω resistive loop.
3. Consider the minimum distance between both clamps.
4. Perform a measurement.
5. After getting the result (it must stay between 3 Ω and 30 Ω) hold the UP key for 10 seconds. If the compensation is successfully performed 'CAL' is displayed.
6. Press now the MEM key to confirm the compensation or any other key to cancel the procedure.

Note:

Be aware that the published technical specifications are not guaranteed in this case.

The instrument reverts to its factory settings after performing a reset.

2.7 Specific Earth Resistance

To ensure accurate calculations, it is advisable to measure the Earth Resistivity, when defining the parameters of the earthing system (required length and surface of earth electrodes, most appropriate depth for installing the earthing system etc.).

The four test probes are driven in at equal distances “a” to a depth of 5 % of “a”. The specific Earth Resistance ρ is calculated by the following formula

$$\rho = 2 \pi a R$$

- a distance between two probes
- R ground resistance between the middle two probes

Different units are used for Earth Resistivity parameter namely:

- Ωm (European countries)
- Ωft (The United States)

This is why the Earth Tester offers both units, as well as allowing the use of both units for the selected distance “a” (m / ft) between the test rods. See the procedure on how to select appropriate unit in chapter 3.4 General settings.

Step 1

- Connect test leads to the instrument and to test rods, in accordance with the figure below.

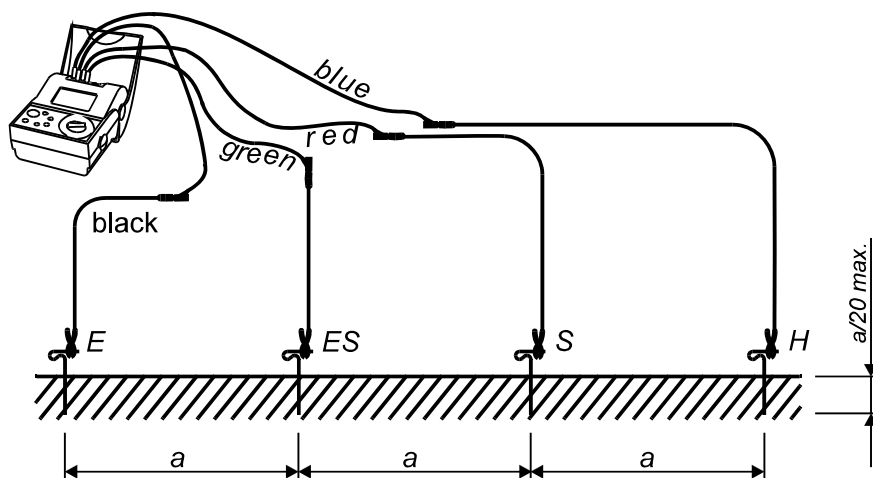

Figure 13. Connection of standard 20 m long test leads

The following table shows typical soil resistivity for several types of soil.

Type of Soil	Soil Resistivity ρ_E [Ωm]
Wet bog soil	8 ... 60
Arable fields, loam and clay, moist gravel	20 ... 300
Moist, sandy soil	200 ... 600
Dry sandy soil, dry gravel	200 ... 2000
Rocky ground	300 ... 8000
Bedrock	10^4 ... 10^{10}

Table 2. Soil Resistivity ρ_E for Various Types of Soil

Step 2

- Set function switch to ρ_{EARTH} position, the following menu will be displayed:

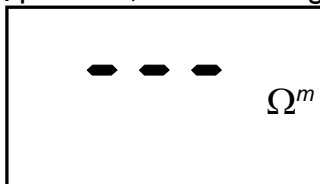

Figure 14. Earth Resistivity initial menu

Step 3

- Set the distance “a” between the test rods. The distance must be the same as the one used in the practical measurement, otherwise the test result will not be correct.



Enter “Distance Value adjustment mode”, the following menu will be displayed:

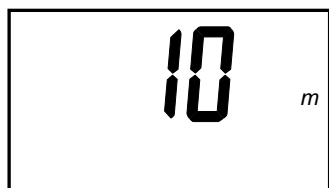

Last set distance »a« is flashing.

Available distances		Step (m / ft)
(m)	(ft)	
1 ÷ 30	1 ÷ 90	1

Figure 15. Distance value adjustment menu



Set appropriate Distance “a”. Single press, will increase/decrease the value for one step, while continuous pressure will increase / decrease it continuously.



Return to “Earth Resistivity initial menu”.

Step 4



View the test result. (If you want to perform more than one measurement press the **START** key and keep it pressed until the result has stabilized, then release the key. The last result will stay displayed.)





Check resistances of current (**Rc**) and potential (**Rp**) test probe. After a short period the main results will automatically be displayed again.

- Store displayed result for documentation purposes, see instructions how to use the memory in chapter 3.1.1.

Repeat the measurement by placing the test probes in different directions and with different distances between them. Check or correct the distance “a” entered into the instrument before every measurement.

Notes!

- If an external voltage higher than 20 Vac/dc. is present between H and E or ES and S test terminals, the Earth Resistivity measurement will not be carried out after pressing **START** key, but the message **> 20 V** will be displayed, marked with  symbol!
- In case of a noise voltage higher than approx. 5 V being present between the H and E or ES and S test terminals, a cursor mark pointing to “” (noise) symbol will be displayed, indicating that the test result may not be correct!
- If the resistance of the current or potential probe is too high ($>(4 \text{ k}\Omega + 100 \text{ RE})$ or $>50 \text{ k}\Omega$, whichever is lower), the test result will be marked with ν symbol and the cursor is displayed on **Rc** and / or **Rp**.
- If the test result is out of the measurement range (for example open test leads), then **>999 k Ω m** ($a < 8\text{m}$) / **>1999 k Ω m** ($a \geq 8 \text{ m}$) or **> 999 k Ω ft** ($a < 8\text{ft}$) / **>1999 k Ω ft** ($a \geq 8\text{ft}$) message will be displayed!

2.8 Current (True RMS)

In complex earthing systems with numerous electrodes connected in parallel or other systems connected to the earthing system, large leakage currents can be present. The shape of the measured current is usually a non-sinusoidal wave. The shape is distorted by various non-linear sources. This is why it is important, that the test instrument measures the true RMS value of the current, otherwise the result can be misleading. Large leakage currents can be caused by different faults in electrical installations or in earthing systems.

- **Do not attach any external voltage between C1 and C2 test terminals!**

Step 1

- Connect current / current (1000:1) test clamp to Earth Tester, see figure 15 or 16. Be aware that sensitive clamp (E-CLIP 1), supplied by METREL, can cover the range 0,5 mA up to 20 A, while standard-range clamp can measure within 10 mA and 20 A.
- Set function switch to **CURRENT** (clamp) position, the following menu will be displayed:

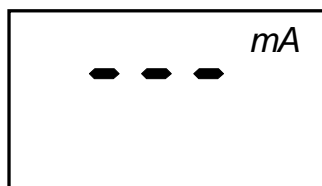

Figure 16. Current function initial menu

Step 2

- Connect sensitive test clamp to the tested object, according to the figures below.

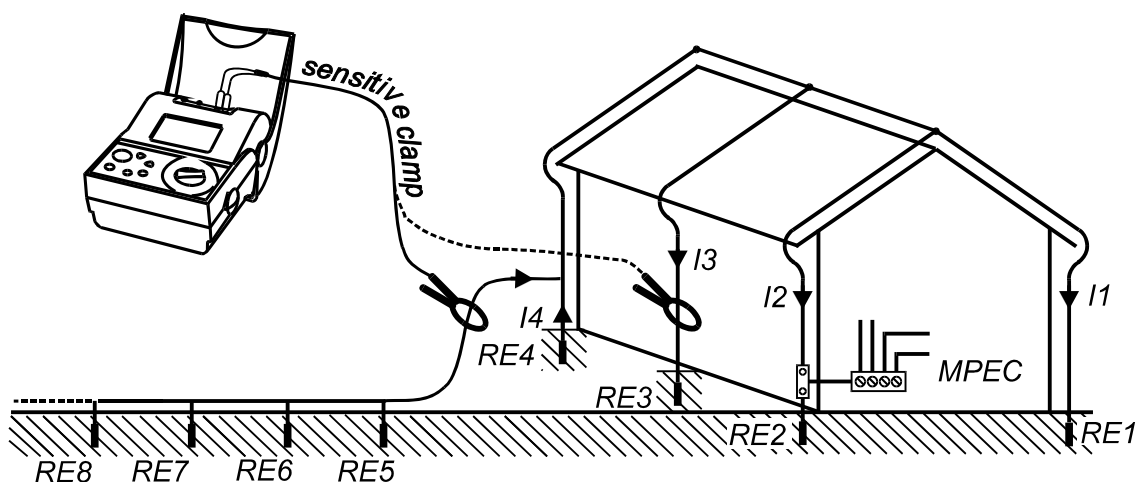

Figure 17. Typical connection of test clamp (when measuring disturbing - noise current)

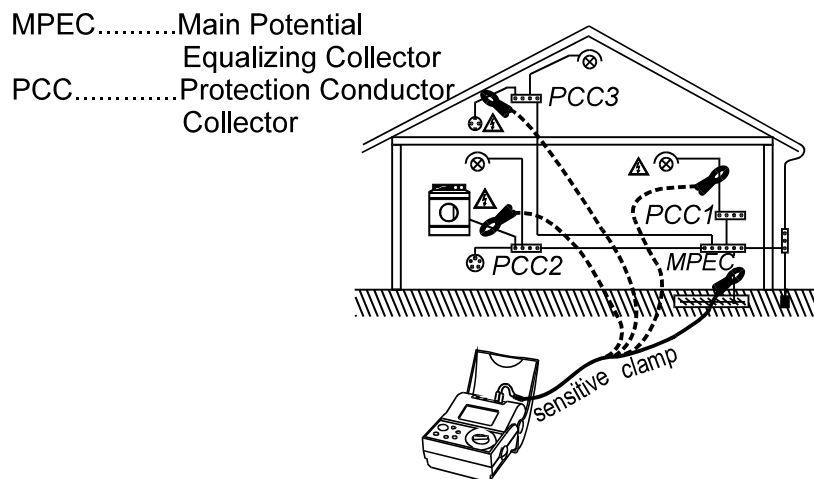

Figure 18. Typical connection of sensitive test clamp (E-CLIP 1) when searching for installation faults

Step 3



Measurement commences (constant measurement), the result is continuously displayed.



Measurement stops, last result will stay displayed.

- Store the displayed result for documentation purpose, see instructions in chapter 3.1.1. Storing of test results.

3 Memory and other operations

3.1 Memory

The memory for the storage of measurement results has a stacking group organization. The operator can organize up to 250 memory locations. Each memory location can stack any measured result. In 'storing result' mode the operator selects a MEM code and then the result is stacked together with all its parameters into the selected memory location.

All results can be stored under a single MEM code, e.g. No.: 001, if there is no need for grouping.

Organization of memory locations, under a specific MEM code, is explained on the figure below.

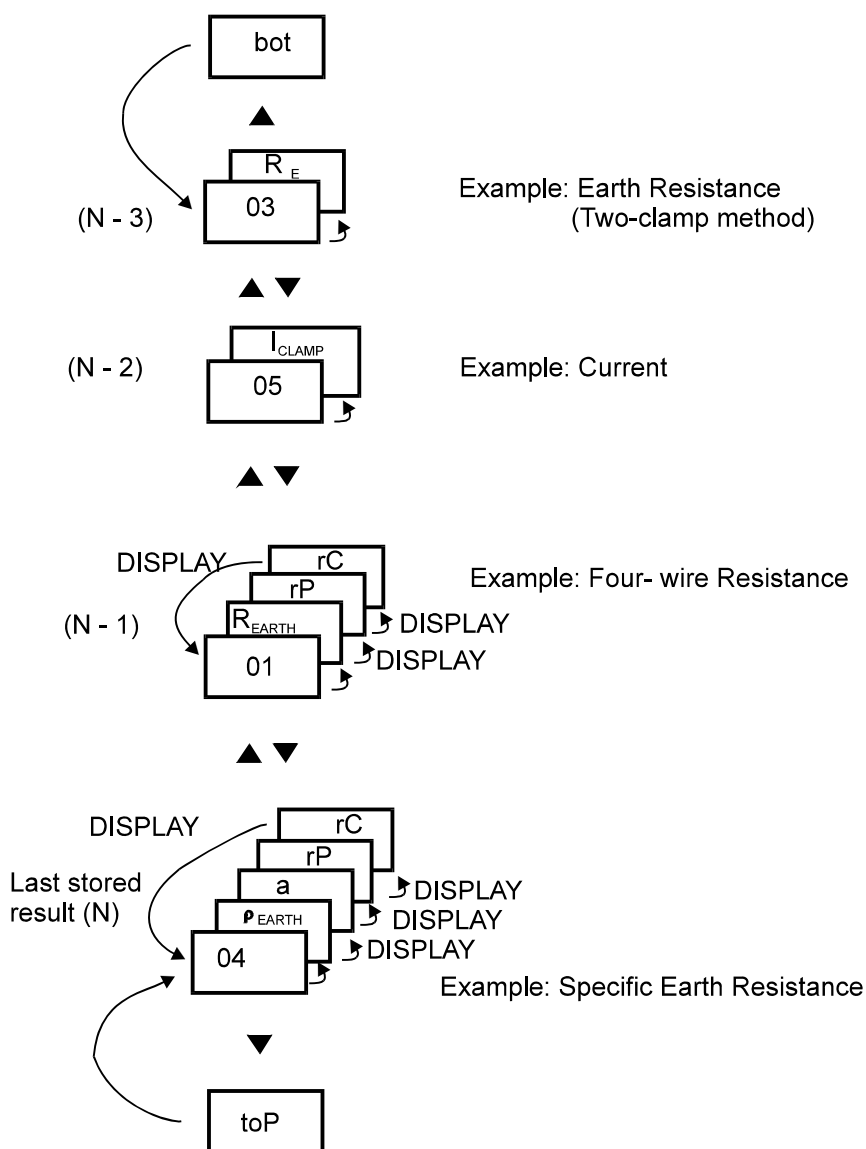

Figure 19. Organization of memory locations

Stored Results and Parameters for each function code

The following is a list of results, subresults, and parameters stored for each function code (FC).

Function	FC	Stored data and parameters	Function	FC	Stored data and parameters
REARTH	1	Earth resistance Potential and current spike resistance (Potential = Rp and current = Rc)	RE two clamps	3	Selective earth resistance
			ρ EARTH	4	Earth resistance Selected distance a Potential and current spike resistance (Potential = Rp and current = Rc)
Rs one clamp	2	Selective earth resistance Potential and current spike resistance (Potential = Rp and current = Rc)	CURRENT TRMS	5	Current

3.1.1 Storing of test results

All test results can be stored for later documentation purpose.

How to store displayed test result.

Once the test result is displayed, the following procedure should be followed:



Last used MEM code is offered (flashing).



Press **UP/DOWN** key to select MEM code, where result is to be stored under. MEM = 1 up to 250 can be selected.



Press **MEM** key to store displayed result under selected MEM code.

After the result is stored, note down the MEM code for later recognition of the stored result.

Main result, potential subresults and potential function parameters as well as Function identification number (see the figure below) are stored, whenever the “MEM” procedure is used.

Further test results (regardless of test function) can be stored under the same MEM code. This can be simply done with a double click to **MEM** key after each measurement.

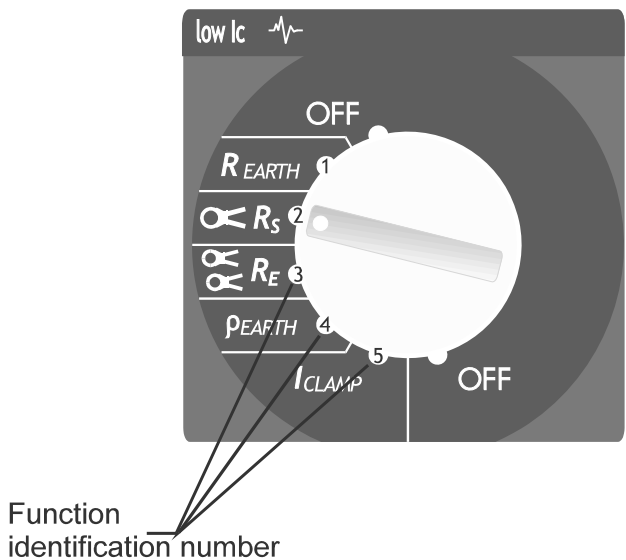

Figure 20. Function identification numbers

Notes!

- Each result can be stored only once.
- Press The **START** key or change rotary switch position to cancel store procedure
- **FUL** message will be displayed when all memory locations are occupied.

3.1.2 Recalling of stored results

Stored results can be displayed whenever needed for visual check. Main result, potential subresult, and potential function parameter can be recalled.

How to recall stored results.



Rcl message will appear on **LCD** for a moment, followed by the last used MEM code (flashing).



Set MEM code.



MEM code will stop flashing. Function identification number (FC) will follow the set MEM code and then the last stored result will appear.

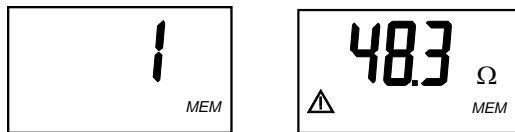

Check subresult and function parameter by pressing the **DISP** key.



Move to other test results, stored under the same MEM code. Function identification number will be displayed, followed by the main result (set by **DISPLAY** key), before using the **UP** and **DOWN** keys.



Check subresult and function parameter.

When the last or first result is reached, “**toP**” or “**bot**” message will appear, followed by that result.

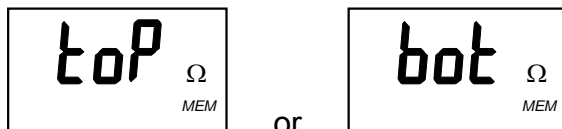

Leave the recall function and return to the selected functions initial display.

If there are no stored results at all then “**no**” message will be displayed after pressing **MEM** key.

If there is no stored result under the set MEM code, “**no**” message will be displayed followed by the selected function idle state.

3.1.3 Erasing stored results

Two modes of erasing the stored results are available namely:

- All stored results can be erased in one step
- The last stored result, can be erased

How to erase all stored results



Press and hold **CLR** key until **Clr MEM / ALL MEM** messages starts to alternate (approx. 3 s).



Confirm erasure, all stored results will be erased.

Press the **START** key or change rotary switch position to cancel clear procedure.

How to erase the last stored result



Press **CLR** key short until Clr MEM message appears.



Confirm erasure.

The procedure may be repeated to erase other stored results.

Press the **START** key or change rotary switch position to cancel the clear procedure.

3.2 RS 232 communication

Stored results can be transferred to PC, where final test reports will be formed. The PC Software **LINK Z591D-Geohm 5** is needed for this operation.

How to transfer stored results

- ◆ Install PC **LINK Z591D-Geohm 5** on PC
- ◆ Set the COM Port settings in Configuration/COM Port menu.
- ◆ Turn the instrument power **ON**
- ◆ Connect PC COM port to the instrument with the serial communication cable as shown on the figure below.

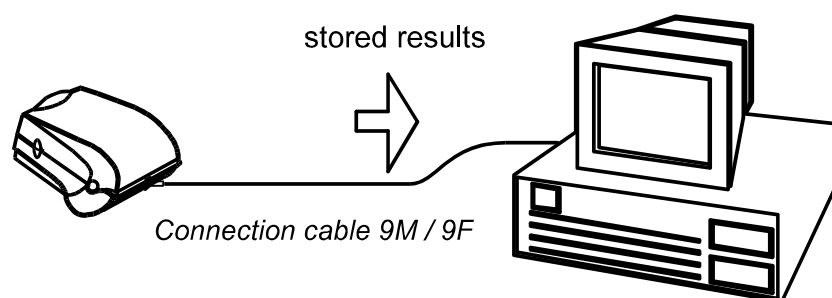

Figure 21. Connection of the Earth Tester to PC

- ◆ Run the **Link.exe** program
- ◆ Push the “Receive Results” button (third from left). The PC and the instrument automatically recognize each other.
- ◆ The program on the PC enables the following procedures:
 - ◆ download data;
 - ◆ prepare a simple report form;
 - ◆ prepare a file to import to a spreadsheet.

3.3 Reset of the instrument

If any malfunction is experienced when dealing with the Earth Tester, it is advisable that **RESET** of the instrument to be carried out. In this instance all parameters will revert to their initial values, see the table below.

How to reset the instrument

Caution!



Before Reset the instrument, transfer all stored data to your PC! All parameters will revert to their initial values!

Switch **OFF** the instrument.



Keep key pressed while switching **ON** the instrument. A flashing **rES** message will be displayed.

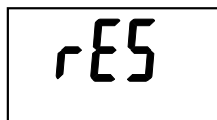

After confirming reset, **rES** message will be displayed for a short period, meaning that the **RESET** function has been completed.

Parameter	Function	Initial value
Frequency		50 Hz
Distance "a" between test rods	ρ EARTH	10 m

Table 2. Initial values of settable parameters

Note!

After performing reset function (**CLR** key), the instrument will automatically enter "Frequency" and "Unit selection" procedure, see next page.

4 Maintenance

4.1 Batteries

The **battery** symbol -  on the upper left corner of the LCD indicates a low battery state ($U_{bat} < 4.2 \text{ V}$). If a low battery state is indicated, the batteries must be replaced to ensure accurate measurements.

Observe the battery condition even when carrying out measurements. Results obtained with low battery voltage (the results may be incorrect) will be marked with  after finishing the measurement.

The instrument is switched off automatically when battery voltage drops below 4.0 V,  is displayed for a few seconds before switching off.

Nominal power supply voltage is 6 V d.c.. Use four 1,5 V alkaline batteries, type IEC LR14 (dimensions: diameter = 26 mm, height = 50 mm).

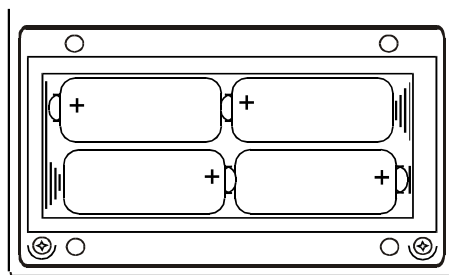



Figure 22. Correct polarity of inserted batteries

One set of full-capacity batteries can supply the instrument for approx. 50 hours.

Rechargeable NiCd or NiMH battery can be used instead of alkaline. The instrument contains an additional connector for charging the batteries.

Caution!

 Transfer stored results to PC, before removing the batteries! The results will be lost when the batteries are removed and all settable parameters will be reset to their initial values after replacing the batteries, see the paragraph 3.3. Reset of the instrument!

 Turn power off and disconnect any measurement accessory connected to the instrument before opening battery cover.

Notes!

- Replace all four batteries at the same time!
- Insert batteries correctly, otherwise test instrument will not operate and batteries may be discharged, see figure 22. for correct battery polarity.
- If the instrument is not to be used for a long period of time remove all batteries from the battery compartment.

To ensure that stored data is not lost the following procedure must be adhered to when replacing the batteries:

- Disconnect all cables
- Switch **OFF** the instrument.
- Replace the batteries within one minute.
- Switch **ON** the instrument, if **Clr mem** message will not be displayed, indicating stored data has not been erased.

Warnings!

- Do not charge when alkaline batteries are fitted!
- Take into account handling, maintenance and recycling requirements as defined by related standards and manufacturer of alkaline or rechargeable batteries.
- Only use the charger supplied by manufacturer of instrument.

4.2 Cleaning

Use soft cloth slightly moistened with soapy water or alcohol, to clean the surface of Earth Tester and leave the instrument to dry totally before using it.

Notes!

- **Do not use liquids based on petrol or hydrocarbons!**
- **Do not spill cleaning liquid over the instrument!**

4.3 Recalibration

The respective measuring task and the stress to which your measuring instrument is subjected affect the ageing of the components and may result in deviations from the guaranteed accuracy.

If high measuring accuracy is required and the instrument is frequently used in field applications, combined with transport stress and great temperature fluctuations, we recommend a relatively short calibration interval of 1 year. If your measuring instrument is mainly used in the laboratory and indoors without being exposed to any major climatic or mechanical stress, a calibration interval of 2-3 years is usually sufficient.

During recalibration* in an accredited calibration laboratory (DIN EN ISO/IEC 17025) the deviations of your instrument in relation to traceable standards are measured and documented. The deviations determined in the process are used for correction of the readings during subsequent application.

* Verification of specifications or adjustment services are not part of the calibration. For products from our factory, however, any necessary adjustment is frequently performed and the observance of the relevant specification is confirmed.

We are pleased to perform DKD or factory calibrations for you in our calibration laboratory. Please visit our website at www.gossenmetrawatt.com (® Services ® DKD Calibration Center or ® FAQs ® Calibration questions and answers).

By having your measuring instrument calibrated regularly, you fulfill the requirements of a quality management system per DIN EN ISO 9001.

4.4 Service

Important!

Unauthorized persons are not allowed to open the Earth Tester. There are no user replaceable components inside the instrument.

4.5 Device Return and Environmentally Compatible Disposal

The instrument is a category 9 product (monitoring and control instrument) in accordance with ElektroG (German Electrical and Electronic Device Law). This device is not subject to the RoHS directive.

We identify our electrical and electronic devices (as of August 2005) in accordance with WEEE 2002/96/EG and ElektroG with the symbol shown to the right per DIN EN 50419.

These devices may not be disposed of with the trash. Please contact our service department regarding the return of old devices.



If you use batteries or rechargeable batteries in your instrument or accessories which no longer function properly, they must be duly disposed of in compliance with the applicable national regulations.

Batteries or rechargeable batteries may contain harmful substances or heavy metal such as lead (Pb), cadmium (Cd) or mercury (Hg).

The symbol shown to the right indicates that batteries or rechargeable batteries may not be disposed of with the trash, but must be delivered to collection points specially provided for this purpose.



5 Technical specification

5.1 Measurement functions

Earth Resistance four-lead method

Measurement range RE (0,11 ÷ 19,99k) Ω

Display range (Ω)	Resolution (Ω)	Accuracy
0,00 ÷ 19,99	0,01	±(2 % rdg. + 3 D)
20,0 ÷ 199,9	0,1	
200 ÷ 999	1	
1,000k ÷ 1,999 k	1	
2,00k ÷ 19,99 k	10	±(5 % rdg.)

Additional spike resistance error at Rc max. or Rp max.	±(3 % of r. + 10 D)
Rc max.	(4 kΩ + 100 RE) or 50 kΩ (whichever is lower)
Rp max.	(4 kΩ + 100 RE) or 50 kΩ (whichever is lower)
Additional error at 3 V voltage noise (50 Hz)	±(5 % of r. +10 D)
Open-terminal test voltage	40 Va.c.
Test voltage shape	sine wave
Test voltage frequency	125 / 150 Hz
Short-circuit test current	< 20 mA
Automatic test of curr. and pot. test probe resistance	yes
Automatic test of voltage noise	yes

Earth Resistance using one clamp in combination with four – lead method

All technical data listed under four-lead method are valid, except display and meas. ranges, see adapted ones below.

Measurement range RE (0,11 ÷ 1,99 k) Ω

Display range (Ω)	Resolution (Ω)	Accuracy
0,00 ÷ 19,99	0,01	±(2 % rdg. + 3 D)
20,0 ÷ 199,9	0,1	
200 ÷ 999	1	
1,00 k ÷ 1,99 k	10	

Additional specification:

Additional error at lowest noise current where noise current symbol is already displayed (valid at max. ratio $R_{\text{Earthtotal}} / R_S = 1/2$)	±(10 % of rdg. + 10 D)
Noise current symbol	>2,1 A approx.
Additional error of resistance ratio	$R_S / R_{\text{Earthtotal}} \cdot 1 \%$
Indication in case of low clamp current	< 0,5 mA
Automatic test of noise current	yes
Additional clamp error is to be considered.	

Earth Resistance using two clamps

Display range RE (Ω)	Resolution (Ω)	Accuracy*
0,0 ÷ 19,9	0,1	$\pm(10\% \text{ rdg.} + 2 \text{ D})$
20 ÷ 100	1	$\pm(20\% \text{ rdg.})$

*Distance between test clamps >30 cm

Additional error at lowest noise curr. where noise curr. symbol is already displayed
 $\pm(10\% \text{ of r.} + 10 \text{ D})$

Noise current indication starts to be displayed at $I_{\text{noise}} / I_{\text{signal}} > 100$
 Additional clamp error is to be considered.

Specific Earth Resistance (resistivity)

All technical data listed under four-lead method are valid, except display range table, see adapted one below.

Display range ρ (Ωm)	Resolution (Ωm)	Accuracy
0,00 ÷ 19,99	0,01	Consider accuracy of RE measurement
20,0 ÷ 199,9	0,1	
200 ÷ 1999	1	
2,00 k ÷ 19,99 k	10	$\rho = 2\pi aRE$
20,0 k ÷ 199,9 k	0.1k	$\pm(5\% \text{ rdg.})$
200 k ÷ 999 k ($a < 8 \text{ m}$) 200 k ÷ 1999 k ($a \geq 8 \text{ m}$)	1k	

Display range ρ (Ωft)	Resolution (Ωft)	Accuracy
0,00 ÷ 19,99	0,01	Consider accuracy of RE measurement
20,0 ÷ 199,9	0,1	
200 ÷ 1999	1	
2,00 k ÷ 19,99 k	10	$\rho = 2\pi aRE$
20,0 k ÷ 199,9 k	0.1 k	$\pm(5\% \text{ rdg.})$
20 k ÷ 999 k ($a < 8 \text{ ft}$) 200 k ÷ 1999 k ($a \geq 8 \text{ ft}$)	1 k	

Distance between test rods 1 up to 30 m or 1 up to 90 ft

Current (True RMS)

Display range I (A)	Resolution (A)	Accuracy
0,0 m ÷ 99,9 m	0,1 m	±(5 % rdg. + 3 D)
100 m ÷ 999 m	1 m	±(5 % rdg.)
1,00 ÷ 9,99	0,01	
10,0 ÷ 19,9	0,1	

Input resistance 10 Ω / 1W

Measurement current clamp 1 A / 1mA

Nominal frequency 50 / 60 Hz

Additional clamp error is to be considered.

Accuracies apply for 1 year in reference conditions. Temperature coefficient outside these limits is 0,1 % of measured value per °C, and 2 digits.

5.2 General characteristics**Power Supply**

Batteries 6 Vdc. (4 × 1,5 V battery per IEC LR14) or
 Rechargeable batt. 4.8 Vdc (4 × 1.2 V NiCd, NiMH rechargeable battery per IEC LR14)
 Charging voltage 6 V
 Charging current 350 mA
 Battery charging 15 hours for full charge
 Battery capacity 3500 mAh
 Auto power off yes, approximately 10 min of no activity

Mechanical Data

Dimensions (w × h × d) 15.5 × 9.5 × 19 cm
 Weight (without accessories, with batteries) 1,3kg
 Display custom LCD
 Memories 1000 measurements
 Computer connection RS 232 (9600 baud, no parity, 8 bit data, 1 stop bit)
 Protection classification double insulation
 Degree of protection IP 54

Ambient Conditions

Working temp. range 0 to + 40 °C
 Nominal (reference) temp. range 10 to + 30 °C
 Max. humidity max. 85 % RH (0 to + 40 °C)
 Nominal (reference) hum. range 40 to 60 % RH, no condensation allowed

6 Standard accessories

- 1 Earth tester
- 1 Case (stackable, lightweight but rugged plastic box)
- 1 Neck strap
- 1 Set batteries
- 4 Earth spikes
- 4 Measurement cables
- 1 Set operating instructions

6.1 Optional accessories

E-Clip 1 Clip-On Meter

Measuring range: 1 mA to 1200 A

Measuring category: 600 V CAT III

Max. cable diameter: 52 mm

Transformation ratio: 1000 A/1A

Frequency range: 40 Hz to 5 kHz

Output signal: 1 μ A to 1.2 A

Supplied with connector cable (1.5 m) and laboratory safety plug

E-Clip 2 Clip-On Generator

Measuring range: 0.2 A to 1200 A

Measuring category: 600 V CAT III

Max. cable diameter: 52 mm

Transformation ratio: 1000 A/1A

Frequency range: 40 Hz to 5 kHz

Output signal: 0.2 mA to 1.2 A

Equipped with laboratory safety plug inputs

Charger

Input: 230 V AC, 50 Hz

Output: 4.8 V DC, 350 mA

Battery charging is indicated by means of a charging display.

7 Repair and Replacement Parts Service, Calibration Center and Rental Instrument Service

If required please contact:

GMC-I Service GmbH
Service Center
Thomas-Mann-Str. 20
90471 Nürnberg, Germany
Phone: +49 911 817718-0
Fax: +49 911 817718-253
e-mail: service@gossenmetrawatt.com
www.gmci-service.com

This address is only valid in Germany.
Please contact our representatives or subsidiaries for
service in other countries.

8 Product Support

If required please contact:

GMC-I Messtechnik GmbH
Product Support Hotline
Phone: +49 911 8602-0
Fax: +49 911 8602-709
e-mail: support@gossenmetrawatt.com

Prepared in Germany • Subject to change without notice • PDF version available on the Internet

 **GOSSEN METRAWATT**
GMC-I Messtechnik GmbH
Südwestpark 15
90449 Nürnberg, Germany

Phone: +49 911 8602-111
Fax: +49 911 8602-777
e-mail: info@gossenmetrawatt.com
www.gossenmetrawatt.com